



**PROTTOLINE**  
accessory design and production

# PRODUCT CATALOG







# ABOUT US

Prottoline is a company that produces and designs accessories for vehicles in the Pickup, SUV and Truck group.

At Prottoline, we redefine the limits of exploration by crafting premium accessories designed specifically for Pickup Trucks, SUVs, and Trucks. As a leading innovator in the automotive accessory industry, we take pride in delivering products that seamlessly blend functionality, style, and durability.

**Precision Engineering:** Every Prottoline product is meticulously engineered to meet the highest standards of quality, durability, and performance. Our commitment to precision ensures that our accessories seamlessly integrate with your vehicle.

**Aesthetics and Functionality:** We believe that great design should not compromise functionality. Prottoline accessories are not just tools; they are statements, enhancing the aesthetic appeal of your vehicle while serving their intended purpose flawlessly.

**Tailored Solutions:** Recognizing the diverse needs of Pickup, SUV, and Truck owners, Prottoline offers tailored solutions for each vehicle type. Our range of accessories is designed to enhance the specific capabilities and features of your vehicle.

**Customer-Centric Approach:** At Prottoline, customer satisfaction is at the core of everything we do. Our dedicated customer support team is ready to assist you, ensuring a seamless experience from product selection to installation.

**We ship products to all countries of the world by cargo**

**We can design and produce our products in the dimensions you want specifically for your vehicle.**

[www.prottoline.com](http://www.prottoline.com)







**PROTTO LINE**  
ACCESSORY DESIGN  
AND PRODUCTION

# OUR PRODUCTS

## ROLL BAR

### Unleash the Power

Upgrade your pick-up's aesthetics and safety with our robust roll bars. Crafted from high-quality materials, our roll bars not only add a rugged look to your truck but also provide additional protection. Choose from various designs to match your style and hit the road with confidence.

## ROOF RACK

### Expand Your Horizon

Maximize your cargo-carrying capacity with our versatile roof racks. Whether you're heading to the mountains or embarking on a camping trip, our roof racks provide a secure and convenient solution for transporting gear, luggage, or outdoor equipment.

## BIKE RACK

### Ready for Adventure

Cyclists, rejoice! Our bike racks offer a secure and stylish way to transport your bicycles wherever your adventures take you. Easy to install and compatible with various bike sizes, our racks ensure that your bikes are securely mounted for a smooth ride.

## REAR BUMPER

### Protect and Perform

Upgrade your pick-up's rear end with our heavy-duty rear bumpers. Built for durability and style, these bumpers not only add protection but also create a distinctive look for your truck. Adventure with confidence, knowing your rear is safeguarded.

## TUBE CLAMPS

### Elevate your ride

Upgrade your vehicle's style and functionality with the simple yet powerful addition of tube clamps – the go-to solution for automotive enthusiasts. These versatile accessories offer a range of applications, allowing you to personalize your ride with ease.

## BED RACK

### Haul with Confidence

Transform your pick-up's bed into a hauling powerhouse with our durable bed racks. Designed to accommodate various cargo sizes, these racks are perfect for carrying camping gear, sports equipment, or any other load you need to transport securely.

## SIDE BAR AND SIDE STEP

### Stylish and Practical

Enhance both the look and functionality of your pick-up with our sleek side bars and convenient side steps. Providing easy access to your truck's cab or bed, these accessories add a touch of style while offering practicality for daily use.

## SLIDE DRAWER

### Organize with Ease

Say goodbye to a cluttered truck bed. Our slide drawers provide a smart and organized storage solution for tools, equipment, and other essentials. Keep everything in its place, making your pick-up not only stylish but also efficient.

## MOTORCYCLE CARRIER

### Ride Anywhere

For motorcycle enthusiasts, our carriers offer a secure and reliable way to transport your bikes. With easy loading and unloading features, these carriers ensure that your motorcycles travel safely, allowing you to hit the open road without compromise.

## TRUCK GUARDS

### Enhance Safety and Style with Truck Guards

Truck guards, including grille guards, bumper guards, and headache racks, are engineered to safeguard your vehicle in various situations.

## AMERICAN PICKUP

### Ruler of the Road

With their magnificent front grilles, wide wheel arches and eye-catching headlight designs, American pickups offer a unique style in every pass.



## MOTO-PROTTO-MOTORCYCLE CARRIER



### Information about the product

<b>Material</b>	Aluminium
<b>Code</b>	MC01
<b>Weight</b>	66 Lbs
<b>Model Year</b>	2015 - 2022
<b>Compatibility</b>	Universal
<b>View Product</b>	<a href="#">Click to Review the Product</a>

### MOTO-PROTTO DIRT BIKE MOTORCYCLE CARRIER HITCH RACK RAMP

**G3 MOTORCYCLE CARRIER OVERVIEW**  
 OUR ORIGINAL MOTORCYCLE, SCOOTER, AND DIRT BIKE HITCH CARRIER - IS NOW ASSEMBLED IN AMERICA. IT CONFIDENTLY HAULS MOTORCYCLES UP TO 500 LBS. WITH TRUSTED COMPONENTS; AN ANGLED STEEL TIRE TRACK, AN ADJUSTABLE WHEEL CHOCK, PATENTED TIE-DOWN ARMS, AND AN INNOVATIVE HITCH MOUNT. PLUS IT INCLUDES A RAMP FOR SAFE SINGLE-PERSON LOADING.

**SPECIFICATIONS:**  
 WEIGHT CAPACITY: 500 LBS (227 KGS.)  
 TIRE WIDTHS: 4.75" (120 MM), FRONT, 6" (152MM) REAR  
 TRACK LENGTH: 72.5" - 78.5" (184 CM - 199 CM)  
 LOADING RAMP LENGTH: 56" (142 CM)  
 CARRIER WEIGHT: 66 LBS. (30 KGS.)

**MOTORCYCLE & VEHICLE COMPATIBILITY**  
 IT IS IMPORTANT YOUR VEHICLE MEET THE HAULING CRITERIA FOR YOUR MOTORCYCLE. TO CALCULATE THE REQUIREMENTS FOR YOUR MOTORCYCLE, ADD THE WEIGHT OF THE CARRIER TO YOUR MOTORCYCLE, THEN MULTIPLY THAT NUMBER BY 10 TO FACTOR IN TONGUE CAPACITY. FOLLOW THIS EXAMPLE TO CALCULATE THE MINIMUM REQUIRED TOWING CAPACITY FOR HAULING A 250 LB. DIRT BIKE WITH AN G3 CARRIER. 250 LBS. (MOTORCYCLE) + 60 LBS. (CARRIER)=310 LBS. 310 LBS. (NET WEIGHT) X 10=3,100 LBS. (MINIMUM REQUIRED TOWING CAPACITY)

**ADDITIONAL EXAMPLES:**  
 300 LB. SCOOTER=3,600 LBS. MINIMUM REQUIRED TOWING CAPACITY FOR THE VEHICLE.  
 400 LB. MOTORCYCLE=4,600 LBS. MINIMUM REQUIRED TOWING CAPACITY FOR THE VEHICLE.

## MOTO-PROTTO-MOTORCYCLE CARRIER-FORD-RANGER

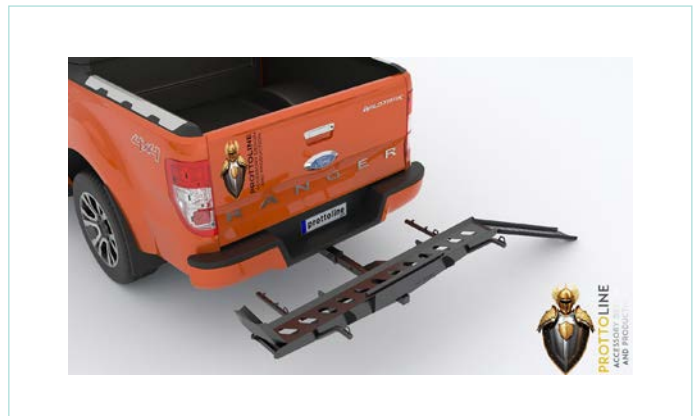

### Information about the product

<b>Material</b>	Aluminium
<b>Code</b>	MC02
<b>Weight</b>	-
<b>Model Year</b>	2015 - 2023
<b>Compatibility</b>	Ford Ranger
<b>View Product</b>	<a href="#">Click to Review the Product</a>

**G3 MOTORCYCLE CARRIER OVERVIEW**  
 OUR ORIGINAL MOTORCYCLE, SCOOTER, AND DIRT BIKE HITCH CARRIER IT CONFIDENTLY HAULS MOTORCYCLES UP TO 500 LBS. WITH TRUSTED COMPONENTS; AN ANGLED STEEL TIRE TRACK, AN ADJUSTABLE WHEEL CHOCK, PATENTED TIE-DOWN ARMS, AND AN INNOVATIVE HITCH MOUNT. PLUS IT INCLUDES A RAMP FOR SAFE SINGLE-PERSON LOADING.

### SPECIFICATIONS:

**WEIGHT CAPACITY:** 500 LBS (227 KGS.)  
**TIRE WIDTHS:** 4.75" (120 MM), FRONT, 6" (152MM) REAR  
**TRACK LENGTH:** 72.5" - 78.5" (184 CM - 199 CM)  
**LOADING RAMP LENGTH:** 56" (142 CM)  
**CARRIER WEIGHT:** 66 LBS. (30 KGS.)

**MOTORCYCLE & VEHICLE COMPATIBILITY**  
 IT IS IMPORTANT YOUR VEHICLE MEET THE HAULING CRITERIA FOR YOUR MOTORCYCLE. TO CALCULATE THE REQUIREMENTS FOR YOUR MOTORCYCLE, ADD THE WEIGHT OF THE CARRIER TO YOUR MOTORCYCLE, THEN MULTIPLY THAT NUMBER BY 10 TO FACTOR IN TONGUE CAPACITY. FOLLOW THIS EXAMPLE TO CALCULATE THE MINIMUM REQUIRED TOWING CAPACITY FOR HAULING A 250 LB. DIRT BIKE WITH AN G3 CARRIER. 250 LBS. (MOTORCYCLE) + 60 LBS. (CARRIER)=310 LBS. 310 LBS. (NET WEIGHT) X 10=3,100 LBS. (MINIMUM REQUIRED TOWING CAPACITY)

**ADDITIONAL EXAMPLES:**  
 300 LB. SCOOTER=3,600 LBS. MINIMUM REQUIRED TOWING CAPACITY FOR THE VEHICLE.  
 400 LB. MOTORCYCLE=4,600 LBS. MINIMUM REQUIRED TOWING CAPACITY FOR THE VEHICLE.







## FOLDING PRO BIKE RACK 2

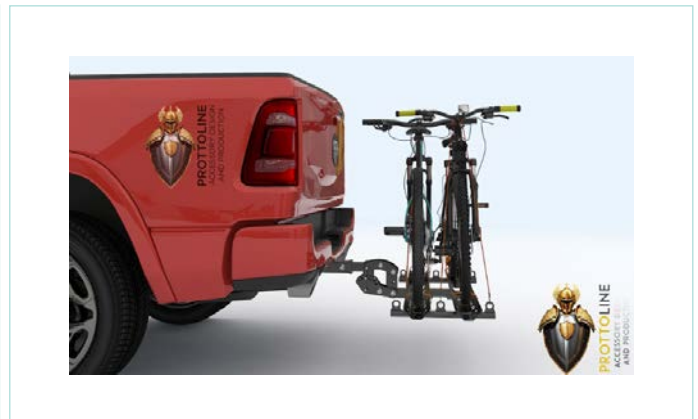

### Information about the product

<b>Material</b>	Aluminium
<b>Code</b>	BKR02
<b>Weight</b>	56 Lbs
<b>Model Year</b>	2012 - 2022
<b>Compatibility</b>	Universal
<b>View Product</b>	<a href="#">Click to Review the Product</a>

2 BIKES UP TO 154LBS ON ROAD AND 92LBS OFF ROAD CAPACITY: MADE OF HEAVY DUTY STEEL AND ALUMINUM WITH E-COATING TO RESIST CORROSION FOR YEARS OF RELIABLE USE, THIS ELECTRIC BIKE RACK IS ENGINEERED DOWN DESIGN FOR TRUNK ACCESS: THIS PRO PLATFORM BIKE RACK CAN BE TILTED DOWN WITH ELECTRIC BICYCLES LOADED FOR TRUNK ACCESS. THIS RACK CAN BE EASILY INSTALLED INTO A 2" HITCH RECEIVER EXCEPT FOR 4X4 WITH A REAR MOUNTED SPARE TIRE WHICH REQUIRES A HITCH EXTENSION  
ACCOMMODATES BIKE WHEELBASES UP TO 53": THANKS TO ADJUSTABLE STABILIZERS & CLAMPS, THIS PRO HITCH BIKE RACK CAN CARRY E-BIKES, MOUNTAIN, ROAD, WOMEN'S SPECIFIC, KIDS AND BMX BICYCLES WITH EASE AND SAFETY. ACCOMMODATES BIKE WHEELBASES UP TO 53"

## FOLDING PRO BIKE RACK 1

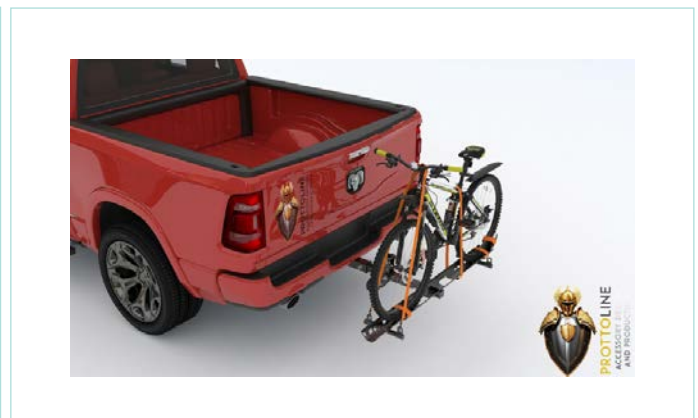

### Information about the product

<b>Material</b>	Aluminium
<b>Code</b>	BKR01
<b>Weight</b>	52 Lbs
<b>Model Year</b>	2012 - 2023
<b>Compatibility</b>	Universal
<b>View Product</b>	<a href="#">Click to Review the Product</a>

1 BIKES UP TO 154LBS ON ROAD AND 92LBS OFF ROAD CAPACITY: MADE OF HEAVY DUTY STEEL AND ALUMINUM WITH E-COATING TO RESIST CORROSION FOR YEARS OF RELIABLE USE, THIS ELECTRIC BIKE RACK IS ENGINEERED DOWN DESIGN FOR TRUNK ACCESS: THIS PRO PLATFORM BIKE RACK CAN BE TILTED DOWN WITH ELECTRIC BICYCLES LOADED FOR TRUNK ACCESS. THIS RACK CAN BE EASILY INSTALLED INTO A 2" HITCH RECEIVER EXCEPT FOR 4X4 WITH A REAR MOUNTED SPARE TIRE WHICH REQUIRES A HITCH EXTENSION  
ACCOMMODATES BIKE WHEELBASES UP TO 53": THANKS TO ADJUSTABLE STABILIZERS & CLAMPS, THIS PRO HITCH BIKE RACK CAN CARRY E-BIKES, MOUNTAIN, ROAD, WOMEN'S SPECIFIC, KIDS AND BMX BICYCLES WITH EASE AND SAFETY. ACCOMMODATES BIKE WHEELBASES UP TO 53"

VW TAIGO BIKE RACK

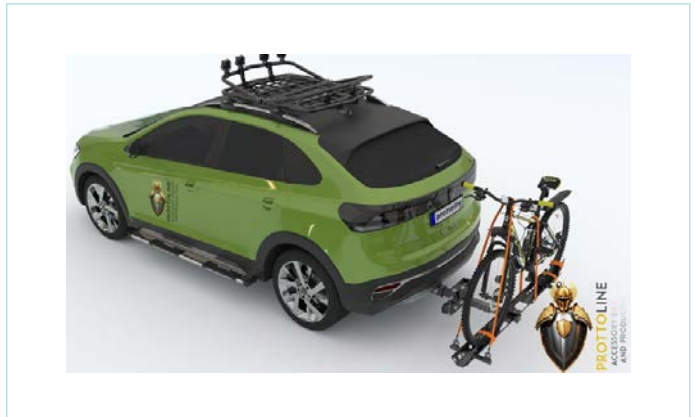

Information about the product

<b>Material</b>	Aluminium
<b>Code</b>	BKR03
<b>Weight</b>	-
<b>Model Year</b>	2023 - 2024
<b>Compatibility</b>	VW TAIGO
<b>View Product</b>	<a href="#">Click to Review the Product</a>

2 BIKES UP TO 154LBS ON ROAD AND 92LBS OFF ROAD CAPACITY: MADE OF HEAVY DUTY STEEL AND ALUMINUM WITH E-COATING TO RESIST CORROSION FOR YEARS OF RELIABLE USE, THIS ELECTRIC BIKE RACK IS ENGINEERED  
 1 BIKES UP TO 154LBS ON ROAD AND 92LBS OFF ROAD CAPACITY: MADE OF HEAVY DUTY STEEL AND ALUMINUM WITH E-COATING TO RESIST CORROSION FOR YEARS OF RELIABLE USE, THIS ELECTRIC BIKE RACK IS ENGINEERED  
 DOWN DESIGN FOR TRUNK ACCESS: THIS PRO PLATFORM BIKE RACK CAN BE TILTED DOWN WITH ELECTRIC BICYCLES LOADED FOR TRUNK ACCESS. THIS RACK CAN BE EASILY INSTALLED INTO A 2" HITCH RECEIVER EXCEPT FOR 4X4 WITH A REAR MOUNTED SPARE TIRE WHICH REQUIRES A HITCH EXTENSION  
 ACCOMMODATES BIKE WHEELBASES UP TO 53": THANKS TO ADJUSTABLE STABILIZERS & CLAMPS, THIS PRO HITCH BIKE RACK CAN CARRY E-BIKES, MOUNTAIN, ROAD, WOMEN'S SPECIFIC, KIDS AND BMX BICYCLES WITH EASE AND SAFETY. ACCOMMODATES BIKE WHEELBASES UP TO 53"





## CHEVROLET-SILVERADO ARMOR ROLL BAR



### Information about the product

<b>Material</b>	Aluminium
<b>Code</b>	AP01
<b>Weight</b>	77 Lbs
<b>Model Year</b>	2016 - 2023
<b>Compatibility</b>	CHEVROLET-SILVERADO
<b>View Product</b>	<a href="#">Click to Review the Product</a>

ARMOR ROLL BAR AND BASKET, NEW STYLE OF ROLL BAR FOR YOUR PICK UP, THE ARMOR ROLL BAR GIVES THAT ULTIMATE OFF ROAD LOOK TO YOUR TRUCK, THE GREAT DESIGN COMBINED WITH TOP QUALITY FINISH MAKES THE HUNTSMAN ROLL BAR A PERFECT CHOICE FOR YOUR PICKUP TRUCK.

THE INSTALLATION OF THIS PRODUCT IS HASSLE-FREE, WITH NO DRILLING REQUIRED. IT IS DESIGNED TO MOUNT EASILY ONTO BED RAILS USING FULLY BOLT-ON INSTALLATION, AND CAN BE EASILY ASSEMBLED AND INSTALLED WITHOUT THE NEED FOR PROFESSIONAL ASSISTANCE. THE PRODUCT IS SHIPPED DISASSEMBLED, MAKING IT EASY TO TRANSPORT AND HANDLE DURING INSTALLATION. THIS PRODUCT IS DESIGNED TO ENDURE HEAVY USE AND EXTREME WEATHER CONDITIONS, OWING TO ITS STURDY CONSTRUCTION MADE OF CARBON STEEL. IT IS FINISHED WITH A TEXTURED BLACK POWDER COAT AND TREATED WITH A HIGH-QUALITY E-COATING PROCESS, GUARANTEEING EXTENDED DURABILITY AND EXCELLENT RESISTANCE TO WEATHER DAMAGE.

## CHEVROLET / SILVERADO LT CREW CAB SHORT BOX SOLDIER ROLL BAR



### Information about the product

<b>Material</b>	Aluminium
<b>Code</b>	AP02
<b>Weight</b>	-
<b>Model Year</b>	2016 - 2023
<b>Compatibility</b>	CHEVROLET-SILVERADO
<b>View Product</b>	<a href="#">Click to Review the Product</a>

SOLDIER ROLL BAR ADD STYLE AND FUNCTIONALITY TO YOUR PICKUP TRUCK. THEY AFFIX TO YOUR TRUCK BED AND ALLOW YOU TO MOUNT ADDITIONAL LIGHTING AND GIVES A MORE RUGGED APPEARANCE. THE PRODUCT IS SHIPPED DISASSEMBLED, MAKING IT EASY TO TRANSPORT AND HANDLE DURING INSTALLATION.

## CHEVROLET-SILVERADO PRO TENT ROLL BAR



### Information about the product

<b>Material</b>	Aluminium
<b>Code</b>	AP03
<b>Weight</b>	100 Lbs
<b>Model Year</b>	2016 - 2022
<b>Compatibility</b>	CHEVROLET-SILVERADO
<b>View Product</b>	<a href="#">Click to Review the Product</a>

THE ADJUSTABLE LOAD BED ROOF TOP TENT CARGO FRAME RACK FOR PICKUP TRUCKS FROM PROTTO LINE SOLVES AN AGE OLD PROBLEM WITH ALL PICKUPS; HOW TO FULLY UTILISE THE LOAD BED AREA, ESPECIALLY IF YOU WANT TO CARRY ITEMS SUCH AS ROOF TOP TENTS. TAKE ALL OF YOUR GEAR WITH YOU ON YOUR NEXT OVERLAND TRIP AND HAVE ROOM TO SPARE! THE PRODUCT IS SHIPPED DISASSEMBLED, MAKING IT EASY TO TRANSPORT AND HANDLE DURING INSTALLATION.

THIS PRODUCT IS DESIGNED TO ENDURE HEAVY USE AND EXTREME WEATHER CONDITIONS, OWING TO ITS STURDY CONSTRUCTION MADE OF CARBON STEEL. IT IS FINISHED WITH A TEXTURED BLACK POWDER COAT AND TREATED WITH A HIGH-QUALITY E-COATING PROCESS, GUARANTEEING EXTENDED DURABILITY AND EXCELLENT RESISTANCE TO WEATHER DAMAGE.

MATT BLACK FINISH  
UNIVERSAL ROLL BAR (UNIVERSAL FITMENT FOR USA MODEL PICKUP TRUCKS)  
INSTRUCTIONS INCLUDED  
WILL FIT MOST PICKUP MODELS BUT IF YOU ARE UNSURE, PLEASE CONTACT OUR SALES TEAM DIRECTLY FOR MORE INFORMATION.

## DODGE RAM 1500 ARMOR ROLL BAR



### Information about the product

<b>Material</b>	Aluminium
<b>Code</b>	AP04
<b>Weight</b>	-
<b>Model Year</b>	2019 - 2022
<b>Compatibility</b>	DODGE RAM 1500
<b>View Product</b>	<a href="#">Click to Review the Product</a>

ARMOR ROLL BAR AND BASKET, NEW STYLE OF ROLL BAR FOR YOUR PICK UP, THE ARMOR ROLL BAR GIVES THAT ULTIMATE OFF ROAD LOOK TO YOUR TRUCK, THE GREAT DESIGN COMBINED WITH TOP QUALITY FINISH MAKES THE HUNTSMAN ROLL BAR A PERFECT CHOICE FOR YOUR PICKUP TRUCK.

THE INSTALLATION OF THIS PRODUCT IS HASSLE-FREE, WITH NO DRILLING REQUIRED. IT IS DESIGNED TO MOUNT EASILY ONTO BED RAILS USING FULLY BOLT-ON INSTALLATION, AND CAN BE EASILY ASSEMBLED AND INSTALLED WITHOUT THE NEED FOR PROFESSIONAL ASSISTANCE. THE PRODUCT IS SHIPPED DISASSEMBLED, MAKING IT EASY TO TRANSPORT AND HANDLE DURING INSTALLATION.

THIS PRODUCT IS DESIGNED TO ENDURE HEAVY USE AND EXTREME WEATHER CONDITIONS, OWING TO ITS STURDY CONSTRUCTION MADE OF CARBON STEEL. IT IS FINISHED WITH A TEXTURED BLACK POWDER COAT AND TREATED WITH A HIGH-QUALITY E-COATING PROCESS, GUARANTEEING EXTENDED DURABILITY AND EXCELLENT RESISTANCE TO WEATHER DAMAGE.



## DODGE RAM 1500 PRO TENT ROLL BAR



### Information about the product

<b>Material</b>	Aluminium
<b>Code</b>	AP05
<b>Weight</b>	-
<b>Model Year</b>	2019 - 2022
<b>Compatibility</b>	DODGE RAM 1500
<b>View Product</b>	<a href="#">Click to Review the Product</a>

THE ADJUSTABLE LOAD BED ROOF TOP TENT CARGO FRAME RACK FOR PICKUP TRUCKS FROM PROTTO LINE SOLVES AN AGE OLD PROBLEM WITH ALL PICKUPS; HOW TO FULLY UTILISE THE LOAD BED AREA, ESPECIALLY IF YOU WANT TO CARRY ITEMS SUCH AS ROOF TOP TENTS. TAKE ALL OF YOUR GEAR WITH YOU ON YOUR NEXT OVERLAND TRIP AND HAVE ROOM TO SPARE! THE PRODUCT IS SHIPPED DISASSEMBLED, MAKING IT EASY TO TRANSPORT AND HANDLE DURING INSTALLATION.

THIS PRODUCT IS DESIGNED TO ENDURE HEAVY USE AND EXTREME WEATHER CONDITIONS, OWING TO ITS STURDY CONSTRUCTION MADE OF CARBON STEEL. IT IS FINISHED WITH A TEXTURED BLACK POWDER COAT AND TREATED WITH A HIGH-QUALITY E-COATING PROCESS, GUARANTEEING EXTENDED DURABILITY AND EXCELLENT RESISTANCE TO WEATHER DAMAGE.  
MATT BLACK FINISH  
UNIVERSAL ROLL BAR (UNIVERSAL FITMENT FOR USA MODEL PICKUP TRUCKS)  
INSTRUCTIONS INCLUDED  
WILL FIT MOST PICKUP MODELS BUT IF YOU ARE UNSURE, PLEASE CONTACT OUR SALES TEAM DIRECTLY FOR MORE INFORMATION.

## DODGE RAM 1500 SOLDIER ROLL BAR



### Information about the product

<b>Material</b>	Aluminium
<b>Code</b>	AP06
<b>Weight</b>	-
<b>Model</b>	2019 - 2022
<b>Compatibility</b>	DODGE RAM 1500
<b>View Product</b>	<a href="#">Click to Review the Product</a>

ROOF BASKET BODY CAN TRANSFORM IN DIFFERENT POSITIONS TO CARRY WIDE VARIETY OF CARGO. THE FRONT AND REAR BAR CAN BE RAISED WHEN LOADED AND LAID FLAT WHEN NOT IN USE OR WHEN LOADING LONG OBJECTS. THIS INNOVATIVE MULTI-CONFIGURATIONS DESIGN PROVIDE YOU WIDE RANGE OF OPTIONS TO HAUL YOUR CARGO WITHOUT THE NEED FOR MULTIPLE DIFFERENT ROOF BASKETS. EASILY TAKE APART FOR STORAGE WHEN NOT USE FOR A LONG TIME. ORIGINAL INNOVATIVE MULTI-CONFIGURATIONS DESIGN  
TOOL-FREE TRANSFORMATIONS  
DETACHABLE AND COLLAPSIBLE DESIGN  
SLIM, LOW PROFILE  
PRODUCT DIMENSIONS : 52 X 43 X 8 INCHES

## FORD F150 RAPTOR ARMOR ROLL BAR



### Information about the product

<b>Material</b>	Aluminium
<b>Code</b>	AP07
<b>Weight</b>	-
<b>Model Year</b>	2021 - 2023
<b>Compatibility</b>	FORD F150
<b>View Product</b>	<a href="#">Click to Review the Product</a>

ARMOR ROLL BAR AND BASKET, NEW STYLE OF ROLL BAR FOR YOUR PICK UP, THE ARMOR ROLL BAR GIVES THAT ULTIMATE OFF ROAD LOOK TO YOUR TRUCK, AND CAN BE EASILY ASSEMBLED AND INSTALLED WITHOUT THE NEED FOR PROFESSIONAL ASSISTANCE. THE PRODUCT IS SHIPPED DISASSEMBLED, MAKING IT EASY TO TRANSPORT AND HANDLE DURING INSTALLATION.

THIS PRODUCT IS DESIGNED TO ENDURE HEAVY USE AND EXTREME WEATHER CONDITIONS, OWING TO ITS STURDY CONSTRUCTION MADE OF CARBON STEEL. IT IS FINISHED WITH A TEXTURED BLACK POWDER COAT AND TREATED WITH A HIGH-QUALITY E-COATING PROCESS, GUARANTEEING EXTENDED DURABILITY AND EXCELLENT RESISTANCE TO WEATHER DAMAGE.

## FORD F150 RAPTOR SOLDIER ROLL BAR



### Information about the product

<b>Material</b>	Aluminium
<b>Code</b>	AP08
<b>Weight</b>	-
<b>Model Year</b>	2021 - 2023
<b>Compatibility</b>	FORD F150
<b>View Product</b>	<a href="#">Click to Review the Product</a>

SOLDIER ROLL BAR ADD STYLE AND FUNCTIONALITY TO YOUR PICKUP TRUCK. THEY AFFIX TO YOUR TRUCK BED AND ALLOW YOU TO MOUNT ADDITIONAL LIGHTING AND GIVES A MORE RUGGED APPEARANCE. THE PRODUCT IS SHIPPED DISASSEMBLED, MAKING IT EASY TO TRANSPORT AND HANDLE DURING INSTALLATION.



## FORD F150 RAPTOR PRO TENT ROLL BAR



### Information about the product

<b>Material</b>	Aluminium
<b>Code</b>	AP09
<b>Weight</b>	-
<b>Model Year</b>	2021 - 2023
<b>Compatibility</b>	FORD F150
<b>View Product</b>	<a href="#">Click to Review the Product</a>

THE ADJUSTABLE LOAD BED ROOF TOP TENT CARGO FRAME RACK FOR PICKUP TRUCKS FROM PROTTOLINE SOLVES AN AGE OLD PROBLEM WITH ALL PICKUPS; HOW TO FULLY UTILISE THE LOAD BED AREA, ESPECIALLY IF YOU WANT TO CARRY ITEMS SUCH AS ROOF TOP TENTS. TAKE ALL OF YOUR GEAR WITH YOU ON YOUR NEXT OVERLAND TRIP AND HAVE ROOM TO SPARE! THE PRODUCT IS SHIPPED DISASSEMBLED, MAKING IT EASY TO TRANSPORT AND HANDLE DURING INSTALLATION.

THIS PRODUCT IS DESIGNED TO ENDURE HEAVY USE AND EXTREME WEATHER CONDITIONS, OWING TO ITS STURDY CONSTRUCTION MADE OF CARBON STEEL. IT IS FINISHED WITH A TEXTURED BLACK POWDER COAT AND TREATED WITH A HIGH-QUALITY E-COATING PROCESS, GUARANTEEING EXTENDED DURABILITY AND EXCELLENT RESISTANCE TO WEATHER DAMAGE.

MATT BLACK FINISH  
UNIVERSAL ROLL BAR (UNIVERSAL FITMENT FOR USA MODEL PICKUP TRUCKS)  
INSTRUCTIONS INCLUDED  
WILL FIT MOST PICKUP MODELS BUT IF YOU ARE UNSURE, PLEASE CONTACT OUR SALES TEAM DIRECTLY FOR MORE INFORMATION.

## GMC CANYON ARMOR ROLL BAR



### Information about the product

<b>Material</b>	Aluminium
<b>Code</b>	AP10
<b>Weight</b>	-
<b>Model</b>	2021 - 2023
<b>Compatibility</b>	GMC CANYON
<b>View Product</b>	<a href="#">Click to Review the Product</a>

ARMOR ROLL BAR AND BASKET, NEW STYLE OF ROLL BAR FOR YOUR PICK UP, THE ARMOR ROLL BAR GIVES THAT ULTIMATE OFF ROAD LOOK TO YOUR TRUCK, THE GREAT DESIGN COMBINED WITH TOP QUALITY FINISH MAKES THE HUNTSMAN ROLL BAR A PERFECT CHOICE FOR YOUR PICKUP TRUCK.

THE INSTALLATION OF THIS PRODUCT IS HASSLE-FREE, WITH NO DRILLING REQUIRED. IT IS DESIGNED TO MOUNT EASILY ONTO BED RAILS USING FULLY BOLT-ON INSTALLATION, AND CAN BE EASILY ASSEMBLED AND INSTALLED WITHOUT THE NEED FOR PROFESSIONAL ASSISTANCE. THE PRODUCT IS SHIPPED DISASSEMBLED, MAKING IT EASY TO TRANSPORT AND HANDLE DURING INSTALLATION.

THIS PRODUCT IS DESIGNED TO ENDURE HEAVY USE AND EXTREME WEATHER CONDITIONS, OWING TO ITS STURDY CONSTRUCTION MADE OF CARBON STEEL. IT IS FINISHED WITH A TEXTURED BLACK POWDER COAT AND TREATED WITH A HIGH-QUALITY E-COATING PROCESS, GUARANTEEING EXTENDED DURABILITY AND EXCELLENT RESISTANCE TO WEATHER DAMAGE.

## GMC CANYON PRO TENT ROLL BAR



### Information about the product

<b>Material</b>	Aluminium
<b>Code</b>	AP11
<b>Weight</b>	-
<b>Model Year</b>	2021 - 2023
<b>Compatibility</b>	GMC CANYON
<b>View Product</b>	<a href="#">Click to Review the Product</a>

THE ADJUSTABLE LOAD BED ROOF TOP TENT CARGO FRAME RACK FOR PICKUP TRUCKS FROM PROTTO LINE SOLVES AN AGE OLD PROBLEM WITH ALL PICKUPS; HOW TO FULLY UTILISE THE LOAD BED AREA, ESPECIALLY IF YOU WANT TO CARRY ITEMS SUCH AS ROOF TOP TENTS. TAKE ALL OF YOUR GEAR WITH YOU ON YOUR NEXT OVERLAND TRIP AND HAVE ROOM TO SPARE! THE PRODUCT IS SHIPPED DISASSEMBLED, MAKING IT EASY TO TRANSPORT AND HANDLE DURING INSTALLATION.

THIS PRODUCT IS DESIGNED TO ENDURE HEAVY USE AND EXTREME WEATHER CONDITIONS, OWING TO ITS STURDY CONSTRUCTION MADE OF CARBON STEEL. IT IS FINISHED WITH A TEXTURED BLACK POWDER COAT AND TREATED WITH A HIGH-QUALITY E-COATING PROCESS, GUARANTEEING EXTENDED DURABILITY AND EXCELLENT RESISTANCE TO WEATHER DAMAGE.

MATT BLACK FINISH  
UNIVERSAL ROLL BAR (UNIVERSAL FITMENT FOR USA MODEL PICKUP TRUCKS)  
INSTRUCTIONS INCLUDED  
WILL FIT MOST PICKUP MODELS BUT IF YOU ARE UNSURE, PLEASE CONTACT OUR SALES TEAM DIRECTLY FOR MORE INFORMATION.

## GMC SIERRA AT4 ARMOR ROLL BAR



### Information about the product

<b>Material</b>	Aluminium
<b>Code</b>	AP12
<b>Weight</b>	-
<b>Model Year</b>	2020 - 2023
<b>Compatibility</b>	GMC SIERRA AT4
<b>View Product</b>	<a href="#">Click to Review the Product</a>

ARMOR ROLL BAR AND BASKET, NEW STYLE OF ROLL BAR FOR YOUR PICK UP, THE ARMOR ROLL BAR GIVES THAT ULTIMATE OFF ROAD LOOK TO YOUR TRUCK, THE GREAT DESIGN COMBINED WITH TOP QUALITY FINISH MAKES THE HUNTSMAN ROLL BAR A PERFECT CHOICE FOR YOUR PICKUP TRUCK.

THE INSTALLATION OF THIS PRODUCT IS HASSLE-FREE, WITH NO DRILLING REQUIRED. IT IS DESIGNED TO MOUNT EASILY ONTO BED RAILS USING FULLY BOLT-ON INSTALLATION, AND CAN BE EASILY ASSEMBLED AND INSTALLED WITHOUT THE NEED FOR PROFESSIONAL ASSISTANCE. THE PRODUCT IS SHIPPED DISASSEMBLED, MAKING IT EASY TO TRANSPORT AND HANDLE DURING INSTALLATION.

THIS PRODUCT IS DESIGNED TO ENDURE HEAVY USE AND EXTREME WEATHER CONDITIONS, OWING TO ITS STURDY CONSTRUCTION MADE OF CARBON STEEL. IT IS FINISHED WITH A TEXTURED BLACK POWDER COAT AND TREATED WITH A HIGH-QUALITY E-COATING PROCESS, GUARANTEEING EXTENDED DURABILITY AND EXCELLENT RESISTANCE TO WEATHER DAMAGE.



## GMC SIERRA AT4 PRO TENT ROLL BAR



### Information about the product

<b>Material</b>	Aluminium
<b>Code</b>	AP13
<b>Weight</b>	-
<b>Model Year</b>	2020 - 2023
<b>Compatibility</b>	GMC SIERRA AT4
<b>View Product</b>	<a href="#">Click to Review the Product</a>

THE ADJUSTABLE LOAD BED ROOF TOP TENT CARGO FRAME RACK FOR PICKUP TRUCKS FROM PROTTO LINE SOLVES AN AGE OLD PROBLEM WITH ALL PICKUPS; HOW TO FULLY UTILISE THE LOAD BED AREA, ESPECIALLY IF YOU WANT TO CARRY ITEMS SUCH AS ROOF TOP TENTS. TAKE ALL OF YOUR GEAR WITH YOU ON YOUR NEXT OVERLAND TRIP AND HAVE ROOM TO SPARE! THE PRODUCT IS SHIPPED DISASSEMBLED, MAKING IT EASY TO TRANSPORT AND HANDLE DURING INSTALLATION.

THIS PRODUCT IS DESIGNED TO ENDURE HEAVY USE AND EXTREME WEATHER CONDITIONS, OWING TO ITS STURDY CONSTRUCTION MADE OF CARBON STEEL. IT IS FINISHED WITH A TEXTURED BLACK POWDER COAT AND TREATED WITH A HIGH-QUALITY E-COATING PROCESS, GUARANTEEING EXTENDED DURABILITY AND EXCELLENT RESISTANCE TO WEATHER DAMAGE.

MATT BLACK FINISH  
UNIVERSAL ROLL BAR (UNIVERSAL FITMENT FOR USA MODEL PICKUP TRUCKS)  
INSTRUCTIONS INCLUDED  
WILL FIT MOST PICKUP MODELS BUT IF YOU ARE UNSURE, PLEASE CONTACT OUR SALES TEAM DIRECTLY FOR MORE INFORMATION.

## GMC SIERRA AT4 PR SOLDIER ROLL BAR



### Information about the product

<b>Material</b>	Aluminium
<b>Code</b>	AP14
<b>Weight</b>	-
<b>Model</b>	2020 - 2023
<b>Compatibility</b>	GMC SIERRA AT4
<b>View Product</b>	<a href="#">Click to Review the Product</a>

SOLDIER ROLL BAR ADD STYLE AND FUNCTIONALITY TO YOUR PICKUP TRUCK. THEY AFFIX TO YOUR TRUCK BED AND ALLOW YOU TO MOUNT ADDITIONAL LIGHTING AND GIVES A MORE RUGGED APPEARANCE. THE PRODUCT IS SHIPPED DISASSEMBLED, MAKING IT EASY TO TRANSPORT AND HANDLE DURING INSTALLATION.

DODGE RAM 1500 GREAT WALL STEED NUDGE BAR BULL BAR 60MM

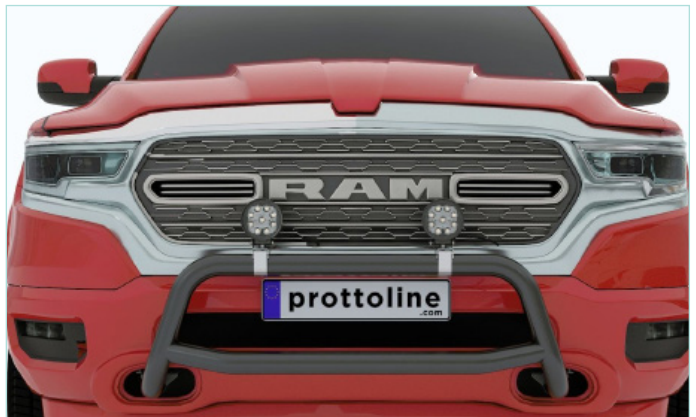

Information about the product

<b>Material</b>	STAINLESS STEEL
<b>Code</b>	AP15
<b>Weight</b>	5,51 Lbs
<b>Model Year</b>	2019 - 2022
<b>Compatibility</b>	DODGE RAM 1500
<b>View Product</b>	<a href="#">Click to Review the Product</a>

FRONT FRAME STAINLESS STEEL, MODEL ADAPTED TO RAM 1500 DT GENERATION 5.

THE FRONT ARCH HAS A WEIGHT LIMIT OF 2.5 KG WHEN MOUNTING ADDITIONAL LIGHTS, SUPPLEMENT WITH CLAMP PT-1002 AS NO BRACKETS FOR MOUNTING ADDITIONAL LIGHTS ARE INCLUDED.

THE FRONT ARCH IS ALSO AVAILABLE IN A BLACK LACQUERED VERSION WITH ARTICLE NUMBER PT-1002.

THE PRODUCTS ARE CHARACTERIZED BY HIGH QUALITY AND ASSEMBLY WITHOUT AFFECTING THE VEHICLE



## VOLVO VNL ('17-) SILVER WITH BRACKET SET DEER ANIMAL MOOSE GUARD BUMPER

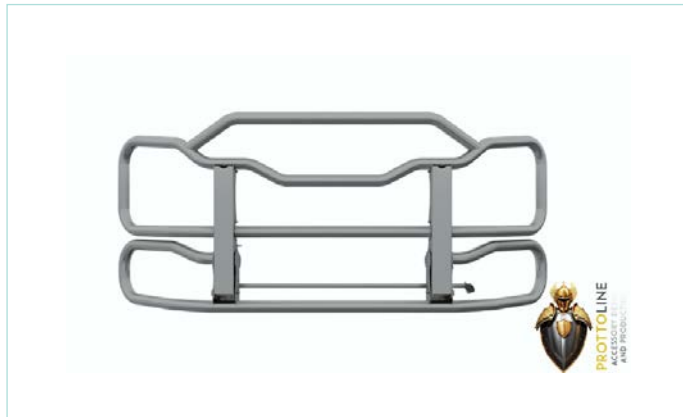

### Information about the product

<b>Material</b>	Aluminium
<b>Code</b>	TG01
<b>Weight</b>	170 Lbs
<b>Model Year</b>	2004 - 2022
<b>Compatibility</b>	VOLVO VNL
<b>View Product</b>	<a href="#">Click to Review the Product</a>

SELECT THE SILVER OR BLACK OPTION TO VIEW THE PROTTO LINE ON YOUR RIG.

FITS THE FOLLOWING VOLVO MODELS:

- NEW VNL 300 (2018-2022)
- NEW VNL 400 (2018-2022)
- NEW VNL 740 (2018-2022)
- NEW VNL 760 (2018-2022)
- NEW VNL 860 (2018-2022)
- NEW VNR 300 (2018-2021)
- NEW VNR 400 (2018-2021)
- NEW VNR 640 (2018-2021)

## FREIGHTLINER CASCADIA (NEW GENERATION) HIGH SILVER

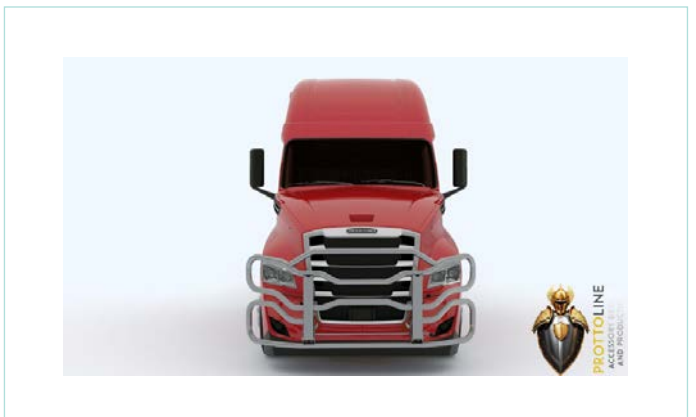

### Information about the product

<b>Material</b>	Aluminium
<b>Code</b>	TG02
<b>Weight</b>	170 Lbs
<b>Model Year</b>	2018 - 2022
<b>Compatibility</b>	CASCADIA FREIGHTLINER
<b>View Product</b>	<a href="#">Click to Review the Product</a>

FITS 2019 - 2023 (126) MODELS WITH OEM PLASTIC BUMPER

SELECT THE SILVER OR BLACK OPTION TO VIEW THE PROTTO LINE ON YOUR RIG.



## BRACKET KITS PR-18VNL



### Information about the product

<b>Material</b>	Aluminium
<b>Code</b>	TG03
<b>Weight</b>	37 Lbs
<b>Model Year</b>	2004 - 2022
<b>Compatibility</b>	
<b>View Product</b>	<a href="#">Click to Review the Product</a>

THIS MOUNTING KIT CONSISTS OF ONE (1) PASSENGER SIDE BRACKET, ONE (1) DRIVER SIDE BRACKET AND ALL NECESSARY HARDWARE FOR INSTALLING THIS KIT.

EASY INSTALLATION, NO DRILLING REQUIRED  
 INCLUDES ALL ASSEMBLY AND MOUNTING HARDWARE  
 COMPATIBLE WITH VOLVO VN/VNL 2018-2022 DEER GUARD  
 LINK THE FRONT BAR TO YOUR TRUCK TO MAKE IT MORE SECURE  
 PROFESSIONAL INSTALLATION IS HIGHLY RECOMMENDED

## BRACKET KITS PR-10FR



### Information about the product

<b>Material</b>	Aluminium
<b>Code</b>	TG04
<b>Weight</b>	-
<b>Model Year</b>	2018 - 2022
<b>Compatibility</b>	
<b>View Product</b>	<a href="#">Click to Review the Product</a>

PR-10FR BRACKET KIT  
 THIS MOUNTING KIT CONSISTS OF ONE (1) PASSENGER SIDE BRACKET, ONE (1) DRIVER SIDE BRACKET AND ALL NECESSARY HARDWARE FOR INSTALLING THIS KIT.

EASY INSTALLATION, NO DRILLING REQUIRED  
 INCLUDES ALL ASSEMBLY AND MOUNTING HARDWARE  
 COMPATIBLE WITH FREIGHTLINER CASCADIA 2018-2022 DEER GUARD  
 LINK THE FRONT BAR TO YOUR TRUCK TO MAKE IT MORE SECURE  
 PROFESSIONAL INSTALLATION IS HIGHLY RECOMMENDED

## FREIGHTLINER CASCADIA (NEW GENERATION) HIGH BLACK

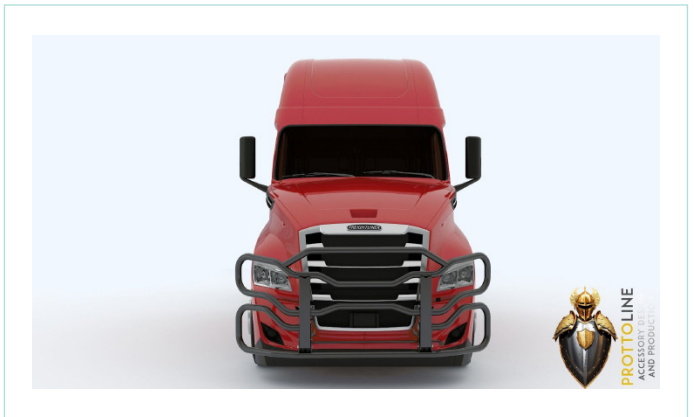

### Information about the product

<b>Material</b>	Aluminium
<b>Code</b>	TG05
<b>Weight</b>	170 Lbs
<b>Model Year</b>	2019 - 2023
<b>Compatibility</b>	CASCADIA FREIGHTLINER
<b>View Product</b>	<a href="#">Click to Review the Product</a>

FITS 2019 - 2023 (126) MODELS WITH OEM PLASTIC BUMPER

SELECT THE SILVER OR BLACK OPTION TO VIEW THE PROTTO LINE ON YOUR RIG.

## FREIGHTLINER CASCADIA BLACK WITH BRACKET SET DEER ANIMAL MOOSE GUARD BUMPER BLACK

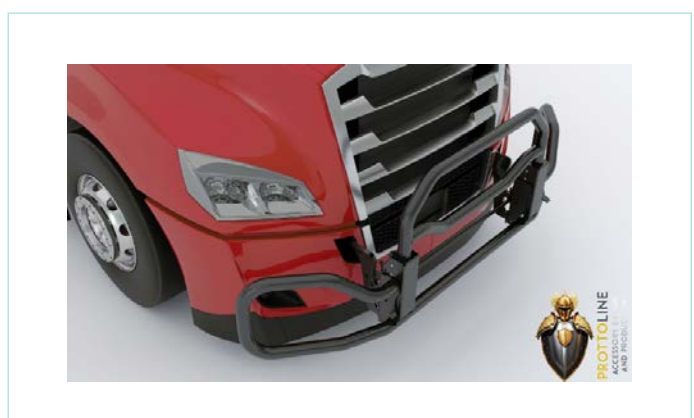

### Information about the product

<b>Material</b>	Aluminium
<b>Code</b>	TG06
<b>Weight</b>	-
<b>Model</b>	2017 - 2022
<b>Compatibility</b>	CASCADIA FREIGHTLINER
<b>View Product</b>	<a href="#">Click to Review the Product</a>

SELECT THE SILVER OR BLACK OPTION TO VIEW THE PROTTO LINE ON YOUR RIG. ANIMAL BUMPER AND BRACKET SET MODEL WILL ENABLE YOUR TRUCK TO AVOID ANY HAZARDOUS RESULTS FROM SUDDEN COLLISIONS WITH LARGE ANIMALS.

## FREIGHTLINER CASCADIA SILVER WITH BRACKET SET DEER ANIMAL MOOSE GUARD BUMPER SILVER

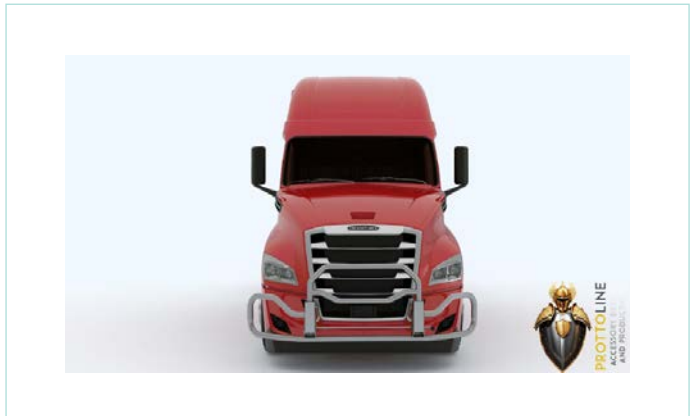

### Information about the product

<b>Material</b>	Aluminium
<b>Code</b>	TG07
<b>Weight</b>	-
<b>Model Year</b>	2017 - 2023
<b>Compatibility</b>	CASCADIA FREIGHTLINER
<b>View Product</b>	<a href="#">Click to Review the Product</a>

SELECT THE SILVER OR BLACK OPTION TO VIEW THE PROTTO LINE ON YOUR RIG. ANIMAL BUMPER AND BRACKET SET MODEL WILL ENABLE YOUR TRUCK TO AVOID ANY HAZARDOUS RESULTS FROM SUDDEN COLLISIONS WITH LARGE ANIMALS.

## VOLVO VNL ('17-) BLACK WITH BRACKET SET DEER ANIMAL MOOSE GUARD BUMPER



### Information about the product

<b>Material</b>	Aluminium
<b>Code</b>	TG08
<b>Weight</b>	-
<b>Model Year</b>	2004 - 2022
<b>Compatibility</b>	VOLVO VNL
<b>View Product</b>	<a href="#">Click to Review the Product</a>

SELECT THE SILVER OR BLACK OPTION TO VIEW THE PROTTO LINE ON YOUR RIG.

FITS THE FOLLOWING VOLVO MODELS:

- NEW VNL 300 (2018-2022)
- NEW VNL 400 (2018-2022)
- NEW VNL 740 (2018-2022)
- NEW VNL 760 (2018-2022)
- NEW VNL 860 (2018-2022)
- NEW VNR 300 (2018-2021)
- NEW VNR 400 (2018-2021)
- NEW VNR 640 (2018-2021)



## VOLVO VNL ('17-) BLACK WITH BRACKET SET DEER ANIMAL MOOSE GUARD BUMPER



### Information about the product

**Material** Aluminium

**Code** TG09

**Weight** -

**Model Year** 2004 - 2023

**Compatibility** VOLVO VNL

**View Product** [Click to Review the Product](#)

SELECT THE SILVER OR BLACK OPTION TO VIEW THE PROTTO LINE ON YOUR RIG. ANIMAL BUMPER AND BRACKET SET MODEL WILL ENABLE YOUR TRUCK TO AVOID ANY HAZARDOUS RESULTS FROM SUDDEN COLLISIONS WITH LARGE ANIMALS.

## VOLVO VNL ('17-) SILVER WITH BRACKET SET DEER ANIMAL MOOSE GUARD BUMPER



### Information about the product

**Material** Aluminium

**Code** TG10

**Weight** -

**Model** 2004 - 2023

**Compatibility** VOLVO VNL

**View Product** [Click to Review the Product](#)

SELECT THE SILVER OR BLACK OPTION TO VIEW THE PROTTO LINE ON YOUR RIG. ANIMAL BUMPER AND BRACKET SET MODEL WILL ENABLE YOUR TRUCK TO AVOID ANY HAZARDOUS RESULTS FROM SUDDEN COLLISIONS WITH LARGE ANIMALS.

**1X STAINLESS STEEL SPOT LIGHT BRACKET -Ø42 MM- Ø60 MM -Ø63MM- Ø70MM- Ø76 MM**



**Information about the product**

<b>Material</b>	Aluminium
<b>Code</b>	TC01
<b>Weight</b>	0.66 Lbs
<b>Model Year</b>	2012 - 2022
<b>Compatibility</b>	Universal
<b>View Product</b>	<a href="#">Click to Review the Product</a>

MADE FROM HIGH QUALITY SUS 304 GRADE STAINLESS STEEL MATERIAL, AND HAND POLISHED TO A MIRROR LIKE FINISH. OUR PRODUCTS PRESENT A QUALITY PRODUCT FOR YOUR TRUCK / VAN OR 4X4 AT A REASONABLE PRICE WHICH ALSO INCLUDES ANTI-BREAK, ANTI-FADE LIFETIME WARRANTY.

AS WELL AS SPOT LAMP HOLDING BRACKETS THESE CAN BE USED TO HOLD BEACONS AND AIR HORNS (ADDITIONAL HOLE MAY NEED TO BE DRILLED IN THE BRACKET TO HOLD AIR HORN).

MADE FROM HIGH QUALITY SUS 304 GRADE STAINLESS STEEL. FITS TO 63MM TUBE - STANDARD TRUCK LIGHT BAR SIZE. SOLD IN SINGLE (X1).

EMAIL & PHONE TECHNICAL SUPPORT. CLAMPS ARE BOXED AND NEW. SPECIFY THE DIAMETER Ø YOU WANT

Please Note: Sales is for single (x1) Clamps, please see other listings for pair (x2).

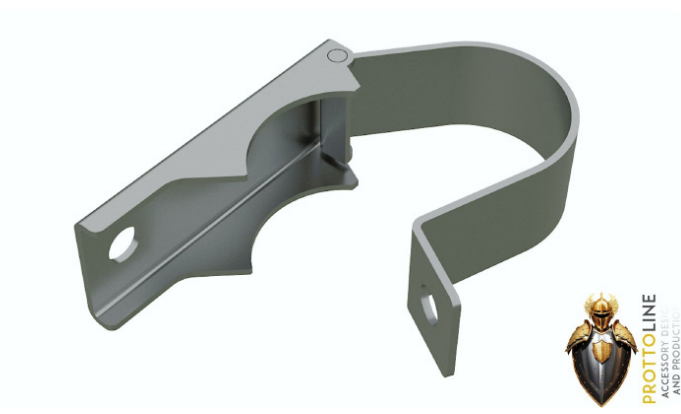

## NAVARA REAR BUMPER



### Information about the product

<b>Material</b>	Aluminium
<b>Code</b>	REB01
<b>Weight</b>	-
<b>Model Year</b>	2016 - 2022
<b>Compatibility</b>	Nissan Navara
<b>View Product</b>	<a href="#">Click to Review the Product</a>

OUR ALL NEW OFF ROAD PROFF REAR BUMPER STYLE OFF ROAD BUMPER UPGRADE IS IDEAL FOR EVERY PICK UP DRIVER.

BOTH FUNCTIONAL AND STYLE-ENHANCING, THE BUMPER COMES WITH REVERSING AND NUMBER PLATE LIGHTS, AS WELL AS EASY TO DRILL OUT HOLES FOR PARKING SENSORS AN "AMERICAN" STYLE TOW BALL CAN BE EASILY ADDED TO THE SLOT ON THE BUMPER SO YOU ARE ABLE TO USE FOR TOWING (TOW BAR BALL NOT INCLUDED)

THE HIGH QUALITY PROFF REAR BUMPER OFF ROAD BUMPER IS CAREFULLY PREPARED, SANDBLASTED AND PRIMED READY FOR A 2 STAGE ELECTROSTATIC PAINTING, THE BOND BETWEEN THE PAINT AND THE STEEL INSURES THE PAINT WILL HOLD UP. THIS GIVES YOU A MUCH LONGER LASTING FINISH THAN STANDARD POWDER COATING.

NON-DRILL INSTALLATION

COMES WITH FULL FITMENT KIT

2 STAGE ELECTROSTATIC PAINTINGBLACK POWDER COATING GIVES A GREAT FINISH

CAN BE WIRED FOR REVERSING OR WORK LIGHTS

NUMBER PLATE LIGHTS

CAN BE EASILY DRILLED OUT TO FIT PARKING SENSORS

BUY YOUR OFF ROAD WINCH STYLE PROFF REAR BUMPER TODAY TO UPGRADE THE BACK OF YOUR VEHICLE WITH AN AGGRESSIVE STYLE

## HILUX REAR BUMPER

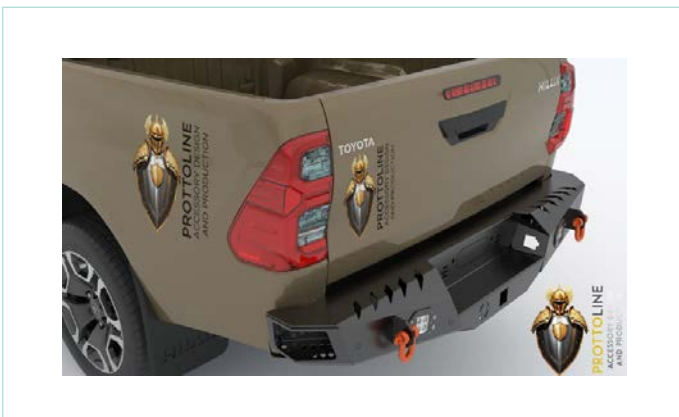

### Information about the product

<b>Material</b>	Aluminium
<b>Code</b>	REB02
<b>Weight</b>	-
<b>Model Year</b>	2016 - 2023
<b>Compatibility</b>	Toyota Hilux
<b>View Product</b>	<a href="#">Click to Review the Product</a>

OUR ALL NEW OFF ROAD PROFF REAR BUMPER STYLE OFF ROAD BUMPER UPGRADE IS IDEAL FOR EVERY PICK UP DRIVER.

BOTH FUNCTIONAL AND STYLE-ENHANCING, THE BUMPER COMES WITH REVERSING AND NUMBER PLATE LIGHTS, AS WELL AS EASY TO DRILL OUT HOLES FOR PARKING SENSORS AN "AMERICAN" STYLE TOW BALL CAN BE EASILY ADDED TO THE SLOT ON THE BUMPER SO YOU ARE ABLE TO USE FOR TOWING (TOW BAR BALL NOT INCLUDED)

THE HIGH QUALITY PROFF REAR BUMPER OFF ROAD BUMPER IS CAREFULLY PREPARED, SANDBLASTED AND PRIMED READY FOR A 2 STAGE ELECTROSTATIC PAINTING, THE BOND BETWEEN THE PAINT AND THE STEEL INSURES THE PAINT WILL HOLD UP. THIS GIVES YOU A MUCH LONGER LASTING FINISH THAN STANDARD POWDER COATING.

NON-DRILL INSTALLATION

COMES WITH FULL FITMENT KIT

2 STAGE ELECTROSTATIC PAINTINGBLACK POWDER COATING GIVES A GREAT FINISH

CAN BE WIRED FOR REVERSING OR WORK LIGHTS

NUMBER PLATE LIGHTS

CAN BE EASILY DRILLED OUT TO FIT PARKING SENSORS

BUY YOUR OFF ROAD WINCH STYLE PROFF REAR BUMPER TODAY TO UPGRADE THE BACK OF YOUR VEHICLE WITH AN AGGRESSIVE STYLE



PRO REAR BUMPER



Information about the product

<b>Material</b>	Aluminium
<b>Code</b>	REB03
<b>Weight</b>	88 Lbs
<b>Model Year</b>	2015 - 2022
<b>Compatibility</b>	Universal
<b>View Product</b>	<a href="#">Click to Review the Product</a>

OUR ALL NEW OFF ROAD PROFF REAR BUMPER STYLE OFF ROAD BUMPER UPGRADE IS IDEAL FOR EVERY PICK UP DRIVER.

BOTH FUNCTIONAL AND STYLE-ENHANCING, THE BUMPER COMES WITH REVERSING AND NUMBER PLATE LIGHTS, AS WELL AS EASY TO DRILL OUT HOLES FOR PARKING SENSORS AN "AMERICAN" STYLE TOW BALL CAN BE EASILY ADDED TO THE SLOT ON THE BUMPER SO YOU ARE ABLE TO USE FOR TOWING (TOW BAR BALL NOT INCLUDED)

THE HIGH QUALITY PROFF REAR BUMPER OFF ROAD BUMPER IS CAREFULLY PREPARED, SANDBLASTED AND PRIMED READY FOR A 2 STAGE ELECTROSTATIC PAINTING, THE BOND BETWEEN THE PAINT AND THE STEEL INSURES THE PAINT WILL HOLD UP. THIS GIVES YOU A MUCH LONGER LASTING FINISH THAN STANDARD POWDER COATING.

NON-DRILL INSTALLATION

COMES WITH FULL FITMENT KIT

2 STAGE ELECTROSTATIC PAINTINGBLACK POWDER COATING GIVES A GREAT FINISH

CAN BE WIRED FOR REVERSING OR WORK LIGHTS

NUMBER PLATE LIGHTS

CAN BE EASILY DRILLED OUT TO FIT PARKING SENSORS

BUY YOUR OFF ROAD WINCH STYLE PROFF REAR BUMPER TODAY TO UPGRADE THE BACK OF YOUR VEHICLE WITH AN AGGRESSIVE STYLE

VW AMAROK REAR BUMPER

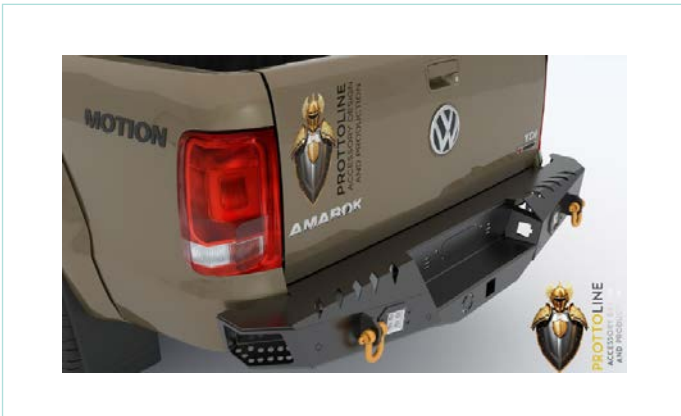

Information about the product

<b>Material</b>	Aluminium
<b>Code</b>	REB04
<b>Weight</b>	-
<b>Model Year</b>	2010 - 2022
<b>Compatibility</b>	VW AMAROK
<b>View Product</b>	<a href="#">Click to Review the Product</a>

OUR ALL NEW OFF ROAD PROFF REAR BUMPER STYLE OFF ROAD BUMPER UPGRADE IS IDEAL FOR EVERY PICK UP DRIVER.

BOTH FUNCTIONAL AND STYLE-ENHANCING, THE BUMPER COMES WITH REVERSING AND NUMBER PLATE LIGHTS, AS WELL AS EASY TO DRILL OUT HOLES FOR PARKING SENSORS AN "AMERICAN" STYLE TOW BALL CAN BE EASILY ADDED TO THE SLOT ON THE BUMPER SO YOU ARE ABLE TO USE FOR TOWING (TOW BAR BALL NOT INCLUDED)

THE HIGH QUALITY PROFF REAR BUMPER OFF ROAD BUMPER IS CAREFULLY PREPARED, SANDBLASTED AND PRIMED READY FOR A 2 STAGE ELECTROSTATIC PAINTING, THE BOND BETWEEN THE PAINT AND THE STEEL INSURES THE PAINT WILL HOLD UP. THIS GIVES YOU A MUCH LONGER LASTING FINISH THAN STANDARD POWDER COATING.

NON-DRILL INSTALLATION

COMES WITH FULL FITMENT KIT

2 STAGE ELECTROSTATIC PAINTINGBLACK POWDER COATING GIVES A GREAT FINISH

CAN BE WIRED FOR REVERSING OR WORK LIGHTS

NUMBER PLATE LIGHTS

CAN BE EASILY DRILLED OUT TO FIT PARKING SENSORS

BUY YOUR OFF ROAD WINCH STYLE PROFF REAR BUMPER TODAY TO UPGRADE THE BACK OF YOUR VEHICLE WITH AN AGGRESSIVE STYLE

## FORD RANGER REAR BUMPER



### Information about the product

<b>Material</b>	Aluminium
<b>Code</b>	REB05
<b>Weight</b>	-
<b>Model Year</b>	2015 - 2022
<b>Compatibility</b>	Ford Ranger
<b>View Product</b>	<a href="#">Click to Review the Product</a>

OUR ALL NEW OFF ROAD PROFF REAR BUMPER STYLE OFF ROAD BUMPER UPGRADE IS IDEAL FOR EVERY PICK UP DRIVER.

BOTH FUNCTIONAL AND STYLE-ENHANCING, THE BUMPER COMES WITH REVERSING AND NUMBER PLATE LIGHTS, AS WELL AS EASY TO DRILL OUT HOLES FOR PARKING SENSORS AN "AMERICAN" STYLE TOW BALL CAN BE EASILY ADDED TO THE SLOT ON THE BUMPER SO YOU ARE ABLE TO USE FOR TOWING (TOW BAR BALL NOT INCLUDED)

THE HIGH QUALITY PROFF REAR BUMPER OFF ROAD BUMPER IS CAREFULLY PREPARED, SANDBLASTED AND PRIMED READY FOR A 2 STAGE ELECTROSTATIC PAINTING, THE BOND BETWEEN THE PAINT AND THE STEEL INSURES THE PAINT WILL HOLD UP. THIS GIVES YOU A MUCH LONGER LASTING FINISH THAN STANDARD POWDER COATING.

NON-DRILL INSTALLATION

COMES WITH FULL FITMENT KIT

2 STAGE ELECTROSTATIC PAINTINGBLACK POWDER COATING GIVES A GREAT FINISH

CAN BE WIRED FOR REVERSING OR WORK LIGHTS

NUMBER PLATE LIGHTS

CAN BE EASILY DRILLED OUT TO FIT PARKING SENSORS

BUY YOUR OFF ROAD WINCH STYLE PROFF REAR BUMPER TODAY TO UPGRADE THE BACK OF YOUR VEHICLE WITH AN AGGRESSIVE STYLE

## L-200 REAR BUMPER



### Information about the product

<b>Material</b>	Aluminium
<b>Code</b>	REB06
<b>Weight</b>	-
<b>Model Year</b>	2015 - 2023
<b>Compatibility</b>	Mitsubishi L-200
<b>View Product</b>	<a href="#">Click to Review the Product</a>

OUR ALL NEW OFF ROAD PROFF REAR BUMPER STYLE OFF ROAD BUMPER UPGRADE IS IDEAL FOR EVERY PICK UP DRIVER.

BOTH FUNCTIONAL AND STYLE-ENHANCING, THE BUMPER COMES WITH REVERSING AND NUMBER PLATE LIGHTS, AS WELL AS EASY TO DRILL OUT HOLES FOR PARKING SENSORS AN "AMERICAN" STYLE TOW BALL CAN BE EASILY ADDED TO THE SLOT ON THE BUMPER SO YOU ARE ABLE TO USE FOR TOWING (TOW BAR BALL NOT INCLUDED)

THE HIGH QUALITY PROFF REAR BUMPER OFF ROAD BUMPER IS CAREFULLY PREPARED, SANDBLASTED AND PRIMED READY FOR A 2 STAGE ELECTROSTATIC PAINTING, THE BOND BETWEEN THE PAINT AND THE STEEL INSURES THE PAINT WILL HOLD UP. THIS GIVES YOU A MUCH LONGER LASTING FINISH THAN STANDARD POWDER COATING.

NON-DRILL INSTALLATION

COMES WITH FULL FITMENT KIT

2 STAGE ELECTROSTATIC PAINTINGBLACK POWDER COATING GIVES A GREAT FINISH

CAN BE WIRED FOR REVERSING OR WORK LIGHTS

NUMBER PLATE LIGHTS

CAN BE EASILY DRILLED OUT TO FIT PARKING SENSORS

BUY YOUR OFF ROAD WINCH STYLE PROFF REAR BUMPER TODAY TO UPGRADE THE BACK OF YOUR VEHICLE WITH AN AGGRESSIVE STYLE

X-CLASS REAR BUMPER



Information about the product

<b>Material</b>	Aluminium
<b>Code</b>	REB07
<b>Weight</b>	-
<b>Model Year</b>	2017 - 2020
<b>Compatibility</b>	Mercedes X Class
<b>View Product</b>	<a href="#">Click to Review the Product</a>

OUR ALL NEW OFF ROAD PROFF REAR BUMPER STYLE OFF ROAD BUMPER UPGRADE IS IDEAL FOR EVERY PICK UP DRIVER.

BOTH FUNCTIONAL AND STYLE-ENHANCING, THE BUMPER COMES WITH REVERSING AND NUMBER PLATE LIGHTS, AS WELL AS EASY TO DRILL OUT HOLES FOR PARKING SENSORS AN "AMERICAN" STYLE TOW BALL CAN BE EASILY ADDED TO THE SLOT ON THE BUMPER SO YOU ARE ABLE TO USE FOR TOWING (TOW BAR BALL NOT INCLUDED)

THE HIGH QUALITY PROFF REAR BUMPER OFF ROAD BUMPER IS CAREFULLY PREPARED, SANDBLASTED AND PRIMED READY FOR A 2 STAGE ELECTROSTATIC PAINTING, THE BOND BETWEEN THE PAINT AND THE STEEL INSURES THE PAINT WILL HOLD UP. THIS GIVES YOU A MUCH LONGER LASTING FINISH THAN STANDARD POWDER COATING.

NON-DRILL INSTALLATION

COMES WITH FULL FITMENT KIT

2 STAGE ELECTROSTATIC PAINTINGBLACK POWDER COATING GIVES A GREAT FINISH

CAN BE WIRED FOR REVERSING OR WORK LIGHTS

NUMBER PLATE LIGHTS

CAN BE EASILY DRILLED OUT TO FIT PARKING SENSORS

BUY YOUR OFF ROAD WINCH STYLE PROFF REAR BUMPER TODAY TO UPGRADE THE BACK OF YOUR VEHICLE WITH AN AGGRESSIVE STYLE



## ARMOR ROLL BAR



### Information about the product

<b>Material</b>	Aluminium
<b>Code</b>	RB01
<b>Weight</b>	77 Lbs
<b>Model Year</b>	2010 - 2022
<b>Compatibility</b>	Universal
<b>View Product</b>	<a href="#">Click to Review the Product</a>

ARMOR ROLL BAR AND BASKET, NEW STYLE OF ROLL BAR FOR YOUR PICK UP, THE ARMOR ROLL BAR GIVES THAT ULTIMATE OFF ROAD LOOK TO YOUR TRUCK, THE GREAT DESIGN COMBINED WITH TOP QUALITY FINISH MAKES THE HUNTSMAN ROLL BAR A PERFECT CHOICE FOR YOUR PICKUP TRUCK.

THE INSTALLATION OF THIS PRODUCT IS HASSLE-FREE, WITH NO DRILLING REQUIRED. IT IS DESIGNED TO MOUNT EASILY ONTO BED RAILS USING FULLY BOLT-ON INSTALLATION, AND CAN BE EASILY ASSEMBLED AND INSTALLED WITHOUT THE NEED FOR PROFESSIONAL ASSISTANCE. THE PRODUCT IS SHIPPED DISASSEMBLED, MAKING IT EASY TO TRANSPORT AND HANDLE DURING INSTALLATION. THIS PRODUCT IS DESIGNED TO ENDURE HEAVY USE AND EXTREME WEATHER CONDITIONS, OWING TO ITS STURDY CONSTRUCTION MADE OF CARBON STEEL. IT IS FINISHED WITH A TEXTURED BLACK POWDER COAT AND TREATED WITH A HIGH-QUALITY E-COATING PROCESS, GUARANTEEING EXTENDED DURABILITY AND EXCELLENT RESISTANCE TO WEATHER DAMAGE.

## SOLDIER ROLL BAR



### Information about the product

<b>Material</b>	Aluminium
<b>Code</b>	RB02
<b>Weight</b>	77 Lbs
<b>Model Year</b>	2010 - 2022
<b>Compatibility</b>	Universal
<b>View Product</b>	<a href="#">Click to Review the Product</a>

SOLDIER ROLL BAR ADD STYLE AND FUNCTIONALITY TO YOUR PICKUP TRUCK. THEY AFFIX TO YOUR TRUCK BED AND ALLOW YOU TO MOUNT ADDITIONAL LIGHTING AND GIVES A MORE RUGGED APPEARANCE. THE PRODUCT IS SHIPPED DISASSEMBLED, MAKING IT EASY TO TRANSPORT AND HANDLE DURING INSTALLATION.

## PRO TENT ROLL BAR



## Information about the product

<b>Material</b>	Aluminium
<b>Code</b>	RB03
<b>Weight</b>	100 Lbs
<b>Model</b>	2010 - 2022
<b>Compatibility</b>	Universal
<b>View Product</b>	<a href="#">Click to Review the Product</a>

THE ADJUSTABLE LOAD BED ROOF TOP TENT CARGO FRAME RACK FOR PICKUP TRUCKS FROM PROTTO LINE SOLVES AN AGE OLD PROBLEM WITH ALL PICKUPS; HOW TO FULLY UTILISE THE LOAD BED AREA, ESPECIALLY IF YOU WANT TO CARRY ITEMS SUCH AS ROOF TOP TENTS. TAKE ALL OF YOUR GEAR WITH YOU ON YOUR NEXT OVERLAND TRIP AND HAVE ROOM TO SPARE! THE PRODUCT IS SHIPPED DISASSEMBLED, MAKING IT EASY TO TRANSPORT AND HANDLE DURING INSTALLATION.

THIS PRODUCT IS DESIGNED TO ENDURE HEAVY USE AND EXTREME WEATHER CONDITIONS, OWING TO ITS STURDY CONSTRUCTION MADE OF CARBON STEEL. IT IS FINISHED WITH A TEXTURED BLACK POWDER COAT AND TREATED WITH A HIGH-QUALITY E-COATING PROCESS, GUARANTEEING EXTENDED DURABILITY AND EXCELLENT RESISTANCE TO WEATHER DAMAGE.

MATT BLACK FINISH  
UNIVERSAL ROLL BAR (UNIVERSAL FITMENT FOR EUROPEAN MODEL PICKUP TRUCKS)  
INSTRUCTIONS INCLUDED  
WILL FIT MOST PICKUP MODELS BUT IF YOU ARE UNSURE, PLEASE CONTACT OUR SALES TEAM DIRECTLY FOR MORE INFORMATION.

## SUZUKI JIMNY ALUMINIUM PROTTOLINE ROOF RACK LUGGAGE RACK



### Information about the product

<b>Material</b>	Aluminium
<b>Code</b>	RR01
<b>Weight</b>	39 Lbs
<b>Model Year</b>	2019 - 2022
<b>Compatibility</b>	Suzuki Kimy
<b>View Product</b>	<a href="#">Click to Review the Product</a>

### SUZUKI JIMNY 2019 ONWARDS ROOF RACK

A STYLISH ROOF RACK TO SUIT THE LATEST SUZUKI JIMNY, MADE FROM LIGHTWEIGHT ALUMINIUM, AND POWDER COATED BLACK FOR WEATHER PROTECTION.

VERY STRONG PROFILED PLATE AND FULLY BOLT TOGETHER THE ROOF RACK WILL NEED ASSEMBLY BUT WE GIVE FULL INSTRUCTIONS WITH THE KIT AFTER TEST FITTING ONE TO OUR JIMNY. ONE OF THE BEST LOOKING RACKS AVAILABLE FOR THE NEW JIMNY MATERIAL ALUMINIUM

## PRO ROOF RACK BASKET

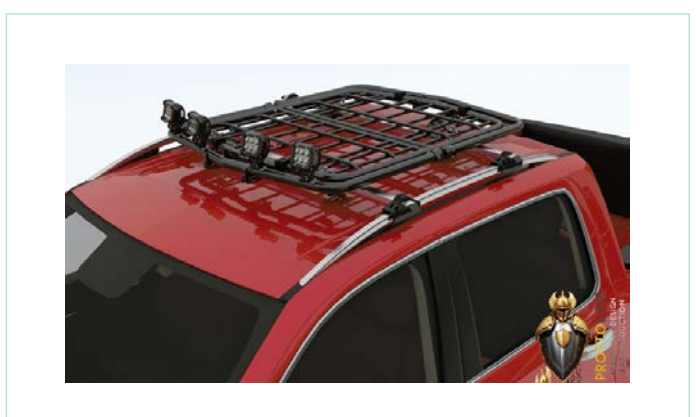

### Information about the product

<b>Material</b>	Aluminium
<b>Code</b>	RR02
<b>Dimensions</b>	52 x 43 x 8 inches
<b>Model Year</b>	2010 - 2022
<b>Compatibility</b>	Universal
<b>View Product</b>	<a href="#">Click to Review the Product</a>

ROOF BASKET BODY CAN TRANSFORM IN DIFFERENT POSITIONS TO CARRY WIDE VARIETY OF CARGO.

THE FRONT AND REAR BAR CAN BE RAISED WHEN LOADED AND LAID FLAT WHEN NOT IN USE OR WHEN LOADING LONG OBJECTS. THIS INNOVATIVE MULTI-CONFIGURATIONS DESIGN PROVIDE YOU WIDE RANGE OF OPTIONS TO HAUL YOUR CARGO WITHOUT THE NEED FOR MULTIPLE DIFFERENT ROOF BASKETS.

EASILY TAKE APART FOR STORAGE WHEN NOT USE FOR A LONG TIME.

ORIGINAL INNOVATIVE MULTI-CONFIGURATIONS DESIGN

TOOL-FREE TRANSFORMATIONS

DETACHABLE AND COLLAPSIBLE DESIGN

SLIM, LOW PROFILE

PRODUCT DIMENSIONS : 52 X 43 X 8 INCHES

QUALITY MADE PRODUCT WEIGHT: 39 LBS



## UNIVERSAL PROTTO ROOF BASKET



### Information about the product

<b>Material</b>	Aluminium
<b>Code</b>	RR03
<b>Weight</b>	33 Lbs
<b>Model Year</b>	2012 - 2022
<b>Compatibility</b>	Universal
<b>View Product</b>	<a href="#">Click to Review the Product</a>

BASKET SIZE: WIDTH = 98CM, LENGTH = 105CM - PERFECT FIT FOR MOST PICKUPS.

OUR ALL NEW PROTTO ROOF BASKET HAS MULTIPLE TIE-DOWN POINTS FOR EXTRA SECURITY. THE PROTTO ROOF BASKET ALSO HAS ATTACHMENTS FOR LIGHT BARS, SPOT LIGHTS AND CAN EASILY FIT REAR MOUNTED WORK LIGHTS.

CAREFULLY PREPARED, SANDBLASTED AND PRIMED READY FOR A 2-STAGE ELECTROSTATIC PAINTING, THE BOND BETWEEN THE PAINT AND THE STEEL INSURES THE PAINT WILL HOLD UP. THIS GIVES YOU A MUCH LONGER LASTING FINISH THAN STANDARD POWDER COATING.

EASY NON-DRILL INSTALLATION  
ELECTROSTATIC PAINT  
COMPATIBLE WITH ROLLER SHUTTERS  
ENHANCES THE LOOK OF YOUR PICKUP  
EASY TO STRAP LOADS TO  
MULTIPLE LIGHT ATTACHMENT POINTS  
TIE DOWN POINTS FOR SECURITY

## VW TAIGO ROOF RACK BASKET



### Information about the product

<b>Material</b>	Aluminium
<b>Code</b>	RR04
<b>Weight</b>	39 Lbs
<b>Model Year</b>	2023 - 2024
<b>Compatibility</b>	VW TAIGO
<b>View Product</b>	<a href="#">Click to Review the Product</a>

ROOF BASKET BODY CAN TRANSFORM IN DIFFERENT POSITIONS TO CARRY WIDE VARIETY OF CARGO.

THE FRONT AND REAR BAR CAN BE RAISED WHEN LOADED AND LAID FLAT WHEN NOT IN USE OR WHEN LOADING LONG OBJECTS.

THIS INNOVATIVE MULTI-CONFIGURATIONS DESIGN PROVIDE YOU WIDE RANGE OF OPTIONS TO HAUL YOUR CARGO WITHOUT THE NEED FOR MULTIPLE DIFFERENT ROOF BASKETS.

EASILY TAKE APART FOR STORAGE WHEN NOT USE FOR A LONG TIME.

ORIGINAL INNOVATIVE MULTI-CONFIGURATIONS DESIGN

TOOL-FREE TRANSFORMATIONS

DETACHABLE AND COLLAPSIBLE DESIGN

SLIM, LOW PROFILE

PRODUCT DIMENSIONS : 52 X 43 X 8 INCHES

## AMAROK UNIVERSAL PROTTO ROOF BASKET

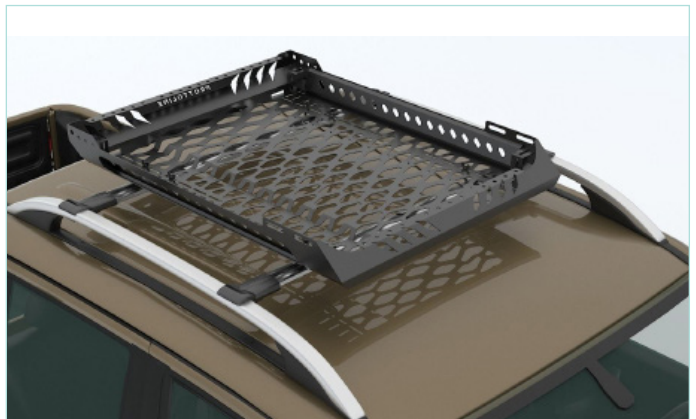

### Information about the product

<b>Material</b>	Aluminium
<b>Code</b>	RR05
<b>Basket Size</b>	Width = 98cm, Length = 105cm – perfect fit for
<b>Model</b>	2010 - 2023
<b>Compatibility</b>	Universal
<b>View Product</b>	<a href="#">Click to Review the Product</a>

OUR ALL NEW PROTTO ROOF BASKET HAS MULTIPLE TIE-DOWN POINTS FOR EXTRA SECURITY. THE PROTTO ROOF BASKET ALSO HAS ATTACHMENTS FOR LIGHT BARS, SPOT LIGHTS AND CAN EASILY FIT REAR MOUNTED WORK LIGHTS.

CAREFULLY PREPARED, SANDBLASTED AND PRIMED READY FOR A 2-STAGE ELECTROSTATIC PAINTING, THE BOND BETWEEN THE PAINT AND THE STEEL INSURES THE PAINT WILL HOLD UP. THIS GIVES YOU A MUCH LONGER LASTING FINISH THAN STANDARD POWDER COATING.

EASY NON-DRILL INSTALLATION  
ELECTROSTATIC PAINT  
COMPATIBLE WITH ROLLER SHUTTERS  
ENHANCES THE LOOK OF YOUR PICKUP  
EASY TO STRAP LOADS TO  
MULTIPLE LIGHT ATTACHMENT POINTS  
TIE DOWN POINTS FOR SECURITY

## VW AMAROK ROOF RACK BASKET

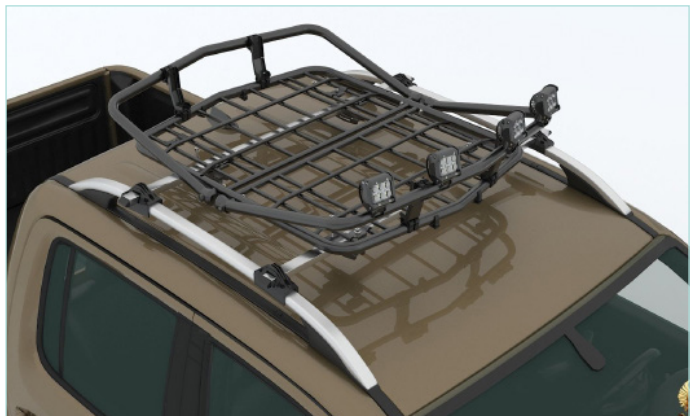
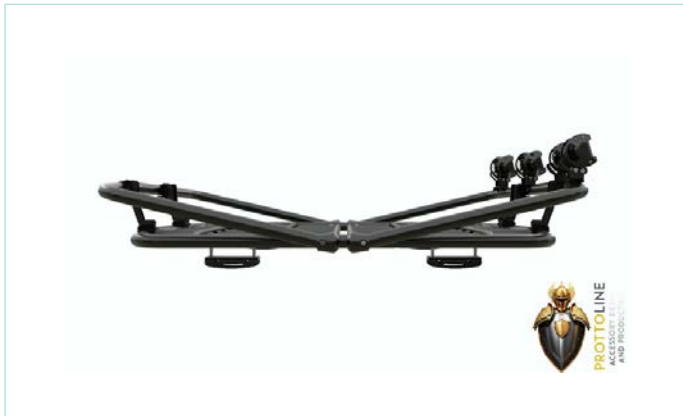

### Information about the product

<b>Material</b>	Aluminium
<b>Code</b>	RR06
<b>Weight</b>	52 x 43 x 8 inches pickups.
<b>Model</b>	2010 - 2023
<b>Compatibility</b>	VW AMAROK
<b>View Product</b>	<a href="#">Click to Review the Product</a>

ROOF BASKET BODY CAN TRANSFORM IN DIFFERENT POSITIONS TO CARRY WIDE VARIETY OF CARGO.

THE FRONT AND REAR BAR CAN BE RAISED WHEN LOADED AND LAID FLAT WHEN NOT IN USE OR WHEN LOADING LONG OBJECTS.

THIS INNOVATIVE MULTI-CONFIGURATIONS DESIGN PROVIDE YOU WIDE RANGE OF OPTIONS TO HAUL YOUR CARGO WITHOUT THE NEED FOR MULTIPLE DIFFERENT ROOF BASKETS.

EASILY TAKE APART FOR STORAGE WHEN NOT USE FOR A LONG TIME.

ORIGINAL INNOVATIVE MULTI-CONFIGURATIONS DESIGN

TOOL-FREE TRANSFORMATIONS

DETACHABLE AND COLLAPSIBLE DESIGN

SLIM, LOW PROFILE

PRODUCT DIMENSIONS : 52 X 43 X 8 INCHES

SLIDER-DRAWER



Information about the product

<b>Material</b>	Aluminium
<b>Code</b>	SD01
<b>Weight</b>	88 Lbs
<b>Model Year</b>	2010 - 2022
<b>Compatibility</b>	Universal
<b>View Product</b>	<a href="#">Click to Review the Product</a>

THIS SLIDER DRAWER IS BOTH FUNCTIONAL AND DURABLE, WITH SMOOTH EXTENSION AND RETRACTION OF THE TRAY. OUR CHEQUERED PLATE'S SLEEK, EFFICIENT DESIGN IS MADE TO REDUCE THE LABOUR OF RETRIEVING GOODS FROM YOUR LOAD BED QUICKLY. OUR SLIDERDRAWER'S SINGLE-HANDED LEVER MECHANISM ENSURES EASY ROLL-OUT WITH MID-WAY LOCKING POINTS FOR EXTRA VERSATILITY AND SECURITY. THESE FEATURES ARE ESPECIALLY USEFUL IF YOUR PICKUP HAS A HARDTOP FITTED. WITH A CARRYING CAPACITY OF 400KG AT FULL EXTENSION, THIS SLIDER DRAWER IS PERFECT FOR HAULING A VARIETY OF GOODS. IT CAN BE USED FOR CARGO LOADING AND UNLOADING, AS A MOBILE WORKSPACE OR FOR PROVIDING EASY ACCESS TO TOOLS. TO ENSURE THAT THE GOODS IN YOUR TRUCK BED DON'T MOVE OR SLIP DURING TRAVEL, OUR SLIDER DRAWERS ARE EQUIPPED WITH A RUGGED CHEQUERED PLATE THAT IS SURE TO KEEP YOUR CARGO IN PLACE. THE CAGED SURROUND TO THE TRAY IS PERFECT TO TIE HEAVY LOADS TO.





**FORD F150 RAPTOR 2021 BED RACK**



**Information about the product**

<b>Material</b>	Aluminium
<b>Code</b>	BR01
<b>Weight</b>	-
<b>Model Year</b>	2004 - 2022
<b>Compatibility</b>	Ford F150
<b>View Product</b>	<a href="#">Click to Review the Product</a>

INTRODUCING THE ONE-OF-A-KIND ADJUSTABLE BED RACK BY PROTTO LINE THAT HAS THE FLEXIBILITY TO MOUNT ON YOUR FORD F150 RAPTOR 2021 AN OUTSTANDING PICK-UP TRUCK BED RACK THAT WILL WITHSTAND THE TOUGHEST TRAILS FOR YEARS TO ENJOY EVERY OFF-ROAD ADVENTURE.

DESIGNED AND MANUFACTURED 100% IN THE TÜRKİYE WORKS WELL WITH FORD F150 RAPTOR 2021 TRUCKS ADJUSTABLE WIDTH ADAPTS TO ANY TRUCK BED FROM INSTALLATION HARDWARE AND INSTRUCTIONS ARE INCLUDED

**CHEVROLET SILVERADO BED RACK**



**Information about the product**

<b>Material</b>	Aluminium
<b>Code</b>	BR02
<b>Weight</b>	-
<b>Model Year</b>	2016 - 2022
<b>Compatibility</b>	Chevrolet Silverado
<b>View Product</b>	<a href="#">Click to Review the Product</a>

INTRODUCING THE ONE-OF-A-KIND ADJUSTABLE BED RACK BY PROTTO LINE THAT HAS THE FLEXIBILITY TO MOUNT ON YOUR FORD F150 RAPTOR 2021 AN OUTSTANDING PICK-UP TRUCK BED RACK THAT WILL WITHSTAND THE TOUGHEST TRAILS FOR YEARS TO ENJOY EVERY OFF-ROAD ADVENTURE.

DESIGNED AND MANUFACTURED 100% IN THE TÜRKİYE WORKS WELL WITH FORD F150 RAPTOR 2021 TRUCKS ADJUSTABLE WIDTH ADAPTS TO ANY TRUCK BED FROM INSTALLATION HARDWARE AND INSTRUCTIONS ARE INCLUDED

**GMC CANYON BED RACK**



**Information about the product**

<b>Material</b>	Aluminium
<b>Code</b>	BR03
<b>Weight</b>	-
<b>Model Year</b>	2021 - 2022
<b>Compatibility</b>	GMC Canyon
<b>View Product</b>	<a href="#">Click to Review the Product</a>

INTRODUCING THE ONE-OF-A-KIND ADJUSTABLE BED RACK BY PROTTO LINE THAT HAS THE FLEXIBILITY TO MOUNT ON YOUR FORD F150 RAPTOR 2021 AN OUTSTANDING PICK-UP TRUCK BED RACK THAT WILL WITHSTAND THE TOUGHEST TRAILS FOR YEARS TO ENJOY EVERY OFF-ROAD ADVENTURE.

DESIGNED AND MANUFACTURED 100% IN THE TÜRKİYE WORKS WELL WITH FORD F150 RAPTOR 2021 TRUCKS ADJUSTABLE WIDTH ADAPTS TO ANY TRUCK BED FROM INSTALLATION HARDWARE AND INSTRUCTIONS ARE INCLUDED

**GMC SIERRA AT4 BED RACK**



**Information about the product**

<b>Material</b>	Aluminium
<b>Code</b>	BR04
<b>Weight</b>	-
<b>Model Year</b>	2020 - 2022
<b>Compatibility</b>	GMC Sierra
<b>View Product</b>	<a href="#">Click to Review the Product</a>

INTRODUCING THE ONE-OF-A-KIND ADJUSTABLE BED RACK BY PROTTO LINE THAT HAS THE FLEXIBILITY TO MOUNT ON YOUR FORD F150 RAPTOR 2021 AN OUTSTANDING PICK-UP TRUCK BED RACK THAT WILL WITHSTAND THE TOUGHEST TRAILS FOR YEARS TO ENJOY EVERY OFF-ROAD ADVENTURE.

DESIGNED AND MANUFACTURED 100% IN THE TÜRKİYE WORKS WELL WITH FORD F150 RAPTOR 2021 TRUCKS ADJUSTABLE WIDTH ADAPTS TO ANY TRUCK BED FROM INSTALLATION HARDWARE AND INSTRUCTIONS ARE INCLUDED

**BED RACK FOR DODGE RAM 1500, 2500, 3500**



**Information about the product**

<b>Material</b>	Aluminium
<b>Code</b>	BR05
<b>Weight</b>	-
<b>Model Year</b>	2007 - 2022
<b>Compatibility</b>	Dodge Ram
<b>View Product</b>	<a href="#">Click to Review the Product</a>

RACK FOR DODGE RAM 1500, 2500 AND 3500 FROM PROTTO LINE OFF ROAD 2007 TO THE 2022 MODELS.

INTRODUCING THE ONE-OF-A-KIND ADJUSTABLE BED RACK BY PROTTO LINE THAT HAS THE FLEXIBILITY TO MOUNT ON YOUR DODGE RAM 1500, 2500, OR 3500. AN OUTSTANDING PICK-UP TRUCK BED RACK THAT WILL WITHSTAND THE TOUGHEST TRAILS FOR YEARS TO ENJOY EVERY OFF-ROAD ADVENTURE.

DESIGNED AND MANUFACTURED 100% IN THE TÜRKİYE WORKS WELL WITH DODGE RAM TRUCKS ADJUSTABLE WIDTH ADAPTS TO ANY TRUCK BED FROM 54" - 64" WIDTH BETWEEN THE BED RAILS WILL SUPPORT 750+ LBS. STATIC LOAD INSTALLATION HARDWARE AND INSTRUCTIONS ARE INCLUDED



## FORD RANGER SIDE BARS



### Information about the product

<b>Material</b>	Aluminium
<b>Code</b>	SB01
<b>Weight</b>	26 Lbs
<b>Model Year</b>	2015-2023
<b>Compatibility</b>	Universal
<b>View Product</b>	<a href="#">Click to Review the Product</a>

ONE PAIR OF ALUMINIUM SIDE STEPS RUNNING BOARDS (DRIVER SIDE + PASSENGER SIDE), AND SIX POWDER COATED STEEL MOUNTING BRACKETS & BOLTS, WITH NECESSARY BOLTS & NUTS.  
 MADE FROM SOLID ALUMINIUM.  
 2015 - 2023 RANGER  
 FITS NEW BODY STYLE CREW CAB MODELS ONLY  
 COME WITH INSTALLATION INSTRUCTION.  
 BOLT STRAIGHT ON THE EXISTING MOUNT HOLES ON THE CHASSIS, NO DRILLING, NO MODIFICATION.  
 BRAND NEW.

## DUAL-SIDE-BARS



### Information about the product

<b>Material</b>	Aluminium
<b>Code</b>	SB02
<b>Weight</b>	26 Lbs
<b>Model Year</b>	2012 - 2022
<b>Compatibility</b>	Universal
<b>View Product</b>	<a href="#">Click to Review the Product</a>

ONE PAIR OF ALUMINIUM SIDE STEPS RUNNING BOARDS (DRIVER SIDE + PASSENGER SIDE), AND SIX POWDER COATED STEEL MOUNTING BRACKETS & BOLTS, WITH NECESSARY BOLTS & NUTS.  
 MADE FROM SOLID ALUMINIUM.  
 2019 - 2022 RAM 1500  
 FITS NEW BODY STYLE CREW CAB MODELS ONLY  
 COME WITH INSTALLATION INSTRUCTION.  
 BOLT STRAIGHT ON THE EXISTING MOUNT HOLES ON THE CHASSIS, NO DRILLING, NO MODIFICATION.  
 BRAND NEW.

## VOLKSWAGEN AMAROK DUAL-SIDE-BARS

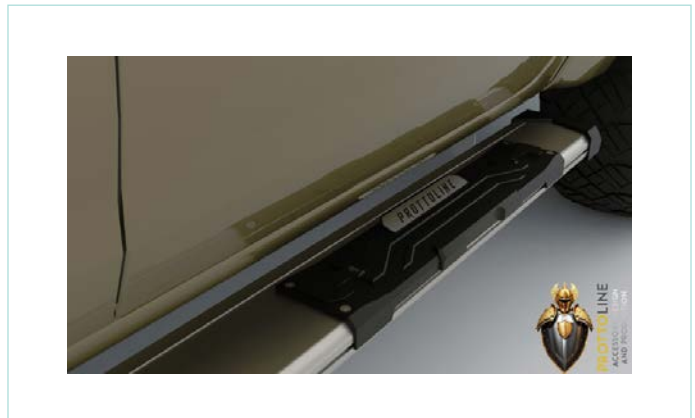

### Information about the product

<b>Material</b>	Aluminium
<b>Code</b>	SB03
<b>Weight</b>	26 Lbs
<b>Model</b>	2010 - 2023
<b>Compatibility</b>	Universal
<b>View Product</b>	<a href="#">Click to Review the Product</a>

ONE PAIR OF ALUMINIUM SIDE STEPS RUNNING BOARDS (DRIVER SIDE + PASSENGER SIDE), AND SIX POWDER COATED STEEL MOUNTING BRACKETS & BOLTS, WITH NECESSARY BOLTS & NUTS.

MADE FROM SOLID ALUMINIUM.

2010 - 2023 AMAROK  
 FITS NEW BODY STYLE CREW CAB MODELS ONLY  
 COME WITH INSTALLATION INSTRUCTION.  
 BOLT STRAIGHT ON THE EXISTING MOUNT HOLES ON THE CHASSIS, NO DRILLING, NO MODIFICATION.

BRAND NEW.

## DODGE RAM 1500 SIDE BARS

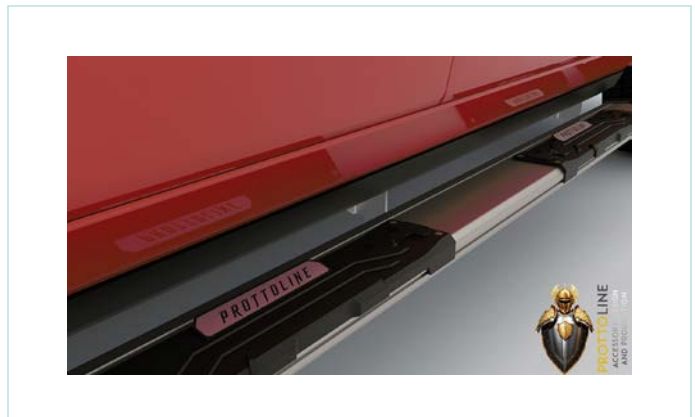

### Information about the product

<b>Material</b>	Aluminium
<b>Code</b>	SB04
<b>Weight</b>	26 Lbs
<b>Model</b>	2019 - 2023
<b>Compatibility</b>	Universal
<b>View Product</b>	<a href="#">Click to Review the Product</a>

ONE PAIR OF ALUMINIUM SIDE STEPS RUNNING BOARDS (DRIVER SIDE + PASSENGER SIDE), AND SIX POWDER COATED STEEL MOUNTING BRACKETS & BOLTS, WITH NECESSARY BOLTS & NUTS.

MADE FROM SOLID ALUMINIUM.

2010 - 2023 AMAROK  
 FITS NEW BODY STYLE CREW CAB MODELS ONLY  
 COME WITH INSTALLATION INSTRUCTION.  
 BOLT STRAIGHT ON THE EXISTING MOUNT HOLES ON THE CHASSIS, NO DRILLING, NO MODIFICATION.

BRAND NEW.

## FORD RANGER SIDE STEP



### Information about the product

<b>Material</b>	Aluminium
<b>Code</b>	SS01
<b>Weight</b>	-
<b>Model Year</b>	2015 - 2023
<b>Compatibility</b>	Ford Ranger
<b>View Product</b>	<a href="#">Click to Review the Product</a>

THE ARMOR SIDE STEPS ARE THE ULTIMATE SIDE STEP DESIGN, GIVING YOUR TRUCK A UNIQUE OFF ROAD STYLE, LIKE NOTHING ELSE ON THE MARKET  
 MANUFACTURED IN TURKEY USING ST37 GRADE 2.5MM STEEL, THEN 2 STAGE BLACK POWDER COATED TO ENSURE A LONG LIFE.  
 VERY EASY INSTALLATION, NO DRILLING REQUIRED, ALL BRACKETS SUPPLIED AND THE SIMPLY MOUNT ONTO EXISTING MOUNTING POINTS ON THE TRUCK  
 WIDTH OF STEP IS 16CM GIVING A MASSIVE AREA TO HELP GET IN AND OUT OF YOUR TRUCK

COMPETE WITH ALL FIXINGS REQUIRED  
 EASY NON-DRILL INSTALLATION  
 MANUFACTURED USING 3MM ST37 STEEL

2 STAGE BLACK POWDER COATING GIVES A GREAT FINISH,

## ARMOR SIDE STEP



### Information about the product

<b>Material</b>	Aluminium
<b>Code</b>	SS02
<b>Weight</b>	66 Lbs
<b>Model Year</b>	2015 - 2023
<b>Compatibility</b>	Universal
<b>View Product</b>	<a href="#">Click to Review the Product</a>

THE ARMOR SIDE STEPS ARE THE ULTIMATE SIDE STEP DESIGN, GIVING YOUR TRUCK A UNIQUE OFF ROAD STYLE, LIKE NOTHING ELSE ON THE MARKET  
 MANUFACTURED IN TURKEY USING ST37 GRADE 2.5MM STEEL, THEN 2 STAGE BLACK POWDER COATED TO ENSURE A LONG LIFE.  
 VERY EASY INSTALLATION, NO DRILLING REQUIRED, ALL BRACKETS SUPPLIED AND THE SIMPLY MOUNT ONTO EXISTING MOUNTING POINTS ON THE TRUCK  
 WIDTH OF STEP IS 16CM GIVING A MASSIVE AREA TO HELP GET IN AND OUT OF YOUR TRUCK

COMPETE WITH ALL FIXINGS REQUIRED  
 EASY NON-DRILL INSTALLATION  
 MANUFACTURED USING 3MM ST37 STEEL  
 2 STAGE BLACK POWDER COATING GIVES A GREAT FINISH,



## AMAROK ARMOR SIDE STEP

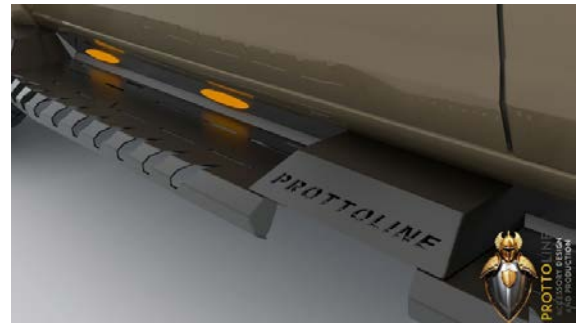

## Information about the product

<b>Material</b>	Aluminium
<b>Code</b>	SS03
<b>Weight</b>	-
<b>Model Year</b>	2010 - 2023
<b>Compatibility</b>	VW AMAROK
<b>View Product</b>	<a href="#">Click to Review the Product</a>

THE ARMOR SIDE STEPS ARE THE ULTIMATE SIDE STEP DESIGN, GIVING YOUR TRUCK A UNIQUE OFF ROAD STYLE, LIKE NOTHING ELSE ON THE MARKET  
 MANUFACTURED IN TURKEY USING ST37 GRADE 2.5MM STEEL, THEN 2 STAGE BLACK POWDER COATED TO ENSURE A LONG LIFE.  
 VERY EASY INSTALLATION, NO DRILLING REQUIRED, ALL BRACKETS SUPPLIED AND THE SIMPLY MOUNT ONTO EXISTING MOUNTING POINTS ON THE TRUCK  
 WIDTH OF STEP IS 16CM GIVING A MASSIVE AREA TO HELP GET IN AND OUT OF YOUR TRUCK

COMPETE WITH ALL FIXINGS REQUIRED  
 EASY NON-DRILL INSTALLATION  
 MANUFACTURED USING 3MM ST37 STEEL  
 2 STAGE BLACK POWDER COATING GIVES A GREAT FINISH,

## DODDE RAM 1500 SIDE STEP



## Information about the product

<b>Material</b>	Aluminium
<b>Code</b>	SS04
<b>Weight</b>	66 Lbs
<b>Model Year</b>	2010 - 2023
<b>Compatibility</b>	VW AMAROK
<b>View Product</b>	<a href="#">Click to Review the Product</a>

THE ARMOR SIDE STEPS ARE THE ULTIMATE SIDE STEP DESIGN, GIVING YOUR TRUCK A UNIQUE OFF ROAD STYLE, LIKE NOTHING ELSE ON THE MARKET  
 MANUFACTURED IN TURKEY USING ST37 GRADE 2.5MM STEEL, THEN 2 STAGE BLACK POWDER COATED TO ENSURE A LONG LIFE.  
 VERY EASY INSTALLATION, NO DRILLING REQUIRED, ALL BRACKETS SUPPLIED AND THE SIMPLY MOUNT ONTO EXISTING MOUNTING POINTS ON THE TRUCK  
 WIDTH OF STEP IS 16CM GIVING A MASSIVE AREA TO HELP GET IN AND OUT OF YOUR TRUCK

COMPETE WITH ALL FIXINGS REQUIRED  
 EASY NON-DRILL INSTALLATION  
 MANUFACTURED USING 3MM ST37 STEEL  
 2 STAGE BLACK POWDER COATING GIVES A GREAT FINISH,



**PROTTOLINE**  
ACCESSORY DESIGN  
AND PRODUCTION

### **Turkey Office Address**

İkitelli OSB Mah. Giyim Sanatkarları 4B Blok  
Sk. Giyim Sanatkarları Tic. Merk. 4B  
Blok No: 4B İç Kapı No: 409  
Başakşehir / İSTANBUL

### **Turkey Office Phone**

+90 533 810 62 98

### **America Office Address**

1001 Nicholas Blvd, Unit P, Elk Grove Village,  
IL, United States, Illinois

### **America Office Phone**

+1 224-423-8860



**/prottoline**

sales@prottoline.com - info@prottoline.com  
www.prottoline.com